



. : www.totalrecallvr.com : .

Total Recall VR Deployment

User Guide

May, 2017

Guide Issue 16.0

Total Recall VR Release 9.20.0 & 10.14.0

Copyright © 2017 [Prolancer Pty Ltd](http://www.prolancer.com.au), Sydney, Australia.

The text of and illustrations in this document are licensed by Prolancer Pty Ltd under a Creative Commons Attribution–Share Alike 3.0 Unported license ("CC-BY-SA"). An explanation of CC-BY-SA is available at <http://creativecommons.org/licenses/by-sa/3.0/>. In accordance with CC-BY-SA, if you distribute this document or an adaptation of it, you must provide the URL for the original version. Prolancer, as the licensor of this document, waives the right to enforce, and agrees not to assert, Section 4d of CC-BY-SA to the fullest extent permitted by applicable law.

Total Recall VR™ is a trade mark of Prolancer Pty Ltd. in Australia and other countries. All other trademarks are the property of their respective owners.

The information in this publication is subject to change without notice. Prolancer Pty Ltd assumes no responsibility for any errors that may appear in this publication.



Prolancer

Related Documents:

[1] Prolancer Pty Ltd, Total Recall VR web site. Available from:
<http://www.totalrecallvr.com/>.

[2] Prolancer Pty Ltd, Prolancer web site. Available from:
<http://www.prolancer.com.au/>.

[3] Prolancer Pty Ltd, Total Recall VR Overview User Guide, 16.0, July 2017

Table of Contents

1. Preface	6
1.1. Conventions.....	6
1.1.1. Notes & Warnings	6
1.2. We Need Feedback	6
2. Introduction	7
2.1. About This Guide.....	7
2.2. What is Total Recall VR?.....	7
3. Safety Information	10
4. Recording Channels	11
4.1. Analogue Recording Channels	11
4.2. VoIP Recording Channels	12
4.2.1. Passive VoIP Recording Channels	13
4.2.2. Active VoIP Recording Channels.....	13
4.3. ISDN Recording Channels.....	15
5. Deployment Concepts	16
5.1. Passive Recording	16
5.2. Active Recording	16
5.2.1. Active Call Recording	16
5.2.2. Active Radio Recording	17
5.3. Extension Side Recording.....	17
5.4. Trunk Side Recording.....	18
5.5. SMDR Integration	19
5.6. Direct Inward Dial Numbers.....	21
5.7. Total Recall VR Extensions	21
5.8. Total Recall VR Recording Policies	23
6. Passive VoIP Recording	25
6.1. Overview.....	25
6.2. Interface.....	25
6.3. Supported Protocols	25
6.4. Deployment Rules.....	25
6.5. VoIP Extensions.....	26
6.6. Packet Capture Methods	26
6.6.1. Ethernet Hub.....	27
6.6.2. Aggregating Ethernet Tap	27
6.6.3. SPAN Port.....	28
6.6.4. Traffic Collector	30
6.7. Deployment Scenarios.....	30
6.7.1. Simple VoIP Networks.....	31
6.7.2. Peer-to-peer VoIP Networks.....	33
6.7.3. Hosted VoIP Networks.....	34

6.7.4.	Complex VoIP Networks	35
7.	Active VoIP Recording	37
7.1.	Overview	37
7.2.	Interface	37
7.3.	Supported Protocols.....	37
7.4.	Deployment Rules	38
7.5.	VoIP Extensions.....	38
7.6.	Deployment Scenarios	38
7.6.1.	Recording Server	39
7.6.2.	Radio Recording	39
8.	RoIP (and AoIP) Recording.....	41
8.1.	Overview	41
8.1.1.	Passive Recording Mode.....	41
8.1.2.	Active Recording Mode	41
8.2.	Interface	41
8.2.1.	Passive Recording Interface	41
8.2.2.	Active Recording Interface	42
8.3.	Supported Protocols.....	42
8.4.	RoIP Extensions.....	42
8.5.	Packet Capture Methods.....	43
8.5.1.	Passive Packet Capture	43
8.5.2.	Active Packet Capture.....	43
8.6.	Deployment Scenarios	44
8.6.1.	Passive RTP Packet Capture	44
8.6.2.	Active RTP Packet Capture	45
8.6.3.	Tait VRP Recording.....	47
9.	ISDN Call Recording	49
9.1.	Overview	49
9.2.	Interface.....	49
9.3.	Supported Protocols.....	50
9.4.	ISDN Extensions	51
9.5.	Deployment Scenarios	51
9.5.1.	Trunk Side ISDN Link.....	51
9.5.2.	Multi-Site ISDN Links.....	52
9.5.3.	ISDN BRI Links	53
10.	Analogue Source Recording.....	54
10.1.	Overview	54
10.2.	Interface	54
10.3.	Supported Protocols.....	55
10.4.	Analogue Extensions.....	55
10.5.	Deployment Scenarios	56
10.5.1.	Analogue Trunk Lines	56
10.5.2.	Analogue Extension Lines	56
10.5.3.	Digital Desk Telephones.....	57

11. Logger Patch Deployment.....	60
11.1. Overview.....	60
11.2. Installation.....	60
11.3. Standard Handset Wiring.....	61
11.4. Non-Standard Handset Wiring.....	62
12. Audio Mixer Deployment.....	63
12.1. Overview.....	63
12.2. Installation.....	64
13. Radio Mixer Deployment.....	64
13.1. Overview.....	64
13.2. Installation.....	65
13.2.1. Motorola TETRA MTM800.....	66
13.2.2. Motorola PMR GM3xx.....	67
13.2.3. Motorola DMR DM3xxx.....	67
14. Remote Manager Interface Application Deployment.....	68
14.1. Overview.....	68
14.2. Application Deployment.....	68
14.2.1. Static IP Addressing.....	68
14.2.2. Hostname Addressing.....	69
14.2.3. Firewall Traversal.....	70
15. Application Notes.....	76
15.1. Zetron DCS-5020.....	76
15.1.1. Overview.....	76
15.1.2. Basic Dual Radio Module (BDRM) Recording.....	77
15.1.3. Dual Telephone Set Module (DSM) Recording.....	77
15.1.4. Dual Telephone Exchange Module (DEM) Recording.....	77
15.2. Omnitronics DX-Altus.....	77
15.2.1. Overview.....	77
15.2.2. TMU Recording.....	79
15.2.3. IPR Recording.....	79
15.3. Tait TN9300.....	79
15.3.1. Overview.....	79
15.3.2. VRP Recording.....	80
15.4. Hytera DMR.....	81
15.4.1. Overview.....	81
15.4.2. Hytera RTP Recording.....	81
16. Glossary.....	84
16.1.1. Terms.....	84
16.1.2. Abbreviations.....	85

1. Preface

1.1. Conventions

Our guides use several conventions to highlight certain words and phrases and draw attention to specific pieces of information.

1.1.1. Notes & Warnings

We use the following visual styles to draw attention to information that might otherwise be overlooked:



Notes are tips, shortcuts or alternative approaches to the task at hand. Ignoring a note should have no negative consequences, but you might miss out on a trick that makes your life easier.



Important boxes detail things that are easily missed: configuration changes that only apply to the current session, or services that need restarting before an update will apply. Ignoring the information will not cause data loss, but may cause irritation and frustration.



Warnings should not be ignored. Ignoring warnings will most likely cause data loss.

1.2. We Need Feedback

If you find a typographical error in this guide, or if you have thought of a way to make this guide better, we would love to hear from you.

Please submit your feedback using the feedback form on our web site:

<http://www.prolancer.com.au/contact/feedback>.

If you have a suggestion for improving the guide, then try to be as specific as possible when describing your suggestion. Otherwise, if you have found an error, please include the section number and some of the surrounding text so we can find it easily.

2. Introduction

2.1. About This Guide

This is a generic deployment guide for Total Recall VR - a professional audio logging and call recording system.

The guide is intended for IT and communication solution designers and pre-sales engineers. It helps decisions on how to best deploy and integrate Total Recall VR with business IT, telephony, radio communication and similar environments.

2.2. What is Total Recall VR?



Total Recall VR is a professional audio logging and call recording system which is self-contained, fully featured and cost-effective. Enterprises and governments worldwide use it to create electronic records of many forms of audio communication including telephone, 2-way radio, broadcast radio, public address, room microphones and much more.

Total Recall VR is the ideal solution for:

- Recording business telephone conversations;
- Recording agent calls in contact centres;
- Logging emergency response communication;
- Logging business operations communication;
- Logging radio broadcasts;
- Logging public announcements;
- Creating audio records of meetings, legal proceedings, public enquiries and similar events; and
- Creating compliance records to meet duty of care and legal requirements.

Total Recall VR captures all audio in digital format and stores it in a proprietary, secure and tamper proof file format in its on-board hard drive storage. The file format preserves the originality of the audio that it stores and has a number of built-in mechanisms that aid quick and reliable detection of tampering. However, for ease of access, Total Recall

VR client applications can generate copies of recordings in a number of popular and everyday formats such as Microsoft's Wave (.wav) and MPEG Layer-3 (.mp3).

Storing audio by itself does not help when looking for one recording in a store that can hold hundreds of thousands of recordings. That is why, in addition to audio, Total Recall VR captures and then stores information related to each recording and audio source in its database such as start time, end time and duration of recordings, calling and called numbers on telephone calls, DTMF digits during calls, user configurable notes and much more. This information is the backbone of a powerful search capability which can pin point a single recording in a set of hundreds of thousands of recordings which reside either on a Total Recall VR or in one of many types of off-system archives of recordings.

In addition to the audio recorder and the on-board storage, each Total Recall VR system comes with a built-in media player with comprehensive player controls (start, stop, fast-forward, rewind ...). The player can play audio stored in files directly on the system or stream audio to a remote client application which then outputs the sound to the PC speakers of the PC that it runs on.

While audio recording, storage and re-play are the main functions of Total Recall VR, every Total Recall VR offers many more advanced, professional-grade features. For example:

- Ability to capture audio from different types of audio sources (analogue, VoIP, RoIP, AoIP and ISDN), at the same time – hybrid recording.
- Live and real-time monitoring (listening) of recordings in progress on the system itself or on a remote PC with the aid of a PC client application.
- Feature-rich archiver which can create searchable archives of recordings on CD, DVD or BD discs, USB keys or drives and network drives, either automatically or on-demand.
- Automated self-cleaning mechanism that removes obsolete recordings automatically and on regular intervals to keep the system operating endlessly.
- Automated transcoder which compresses audio to free space on the on-board hard drives.
- SNMP agent capable of generating SNMP alarms (traps).
- SMDR integration for a number of popular telephone systems.
- Fully internationalised user interface; all menus and software available in multiple languages.
- Role based access control.
- On-board LCD display and control keypad on selected models.
- A number of PC client applications with unrestricted use license.

When audio records are critical to your operations, Total Recall VR delivers. It is professional, reliable and fully self-contained solution for audio logging and call recording that comes at an affordable price.



The Total Recall VR Overview [1] guide contains a comprehensive description and overview of Total Recall VR.

3. Safety Information

Always follow basic safety precautions when deploying and using Total Recall VR to reduce the risk of injury from electrical shock and fire.



WARNING: Potential shock hazard. Total Recall VR must be installed by qualified person.

Observe the following:

1. Read and understand all instructions in all Total Recall VR guides.
2. Observe all warnings and instructions marked on the product.
3. Use only grounded electrical outlet when connecting Total Recall VR to a power source. If you are unsure the outlet is grounded, then have a qualified electrician check it.
4. First connect Total Recall VR to grounded outlet, and only then connect the appropriate interface lines.
5. Do not touch the contacts on the ends of any cables used with Total Recall VR. If any cable becomes damaged, then have it replaced immediately.
6. Shut down and unplug Total Recall VR from telephone jacks, and then from power outlets, prior to moving or cleaning.
7. Do not open Total Recall VR. There are no user serviceable parts inside Total Recall VR. Refer all servicing to qualified personnel.

4. Recording Channels

Successful deployment of a Total Recall VR starts with the understanding of the different types of recording channels that are available on Total Recall VR.

Total Recall VR has three different types of audio recording channels:

1. Analogue recording channels, which are capable of capturing audio from different line level analogue sources and analogue telephone lines.
2. VoIP recording channels, which can operate in passive and active mode.
 - a. In passive mode VoIP recording channels are capable of detecting and capturing SIP, H.323 and RTP packets on IP networks via a SPAN port on an Ethernet switch or an alternative Ethernet link tapping device.
 - b. In active mode VoIP recording channels are capable of processing SIP sessions (calls) as well as receiving raw RTP streams directly on one or both of the system LAN interfaces.
3. ISDN recording channels, which are capable of capturing in passive mode signalling and audio on ISDN PRI telephone links.

In summary, the specification of each type of recording channel is:

4.1. Analogue Recording Channels

Total Recall VR uses a purpose built channel card to capture audio from different types of analogue sources and analogue telephone lines.

Recording trigger:

- Off-hook - 6 off-hook voltage levels: 30V, 25V, 20V, 15V, 10V and 5V.

The off-hook trigger is a DC voltage change trigger. Typical on-hook voltage is above 42V and off-hook is below 15V. Analogue recording channels start recording when they detect voltage that is lower than the one set by the Off-Hook level and stop recording when they detect voltage that is higher than the one set by the Off-Hook level.

- VOX - 6 signal levels: -20dBm (77.5mV), -24dBm (48.9mV), -28dBm (30.8mV), -32dBm (19.5mV), -36dBm (12.3mV) and -40dBm (7.75mV).

The VOX trigger is a signal level trigger. Analogue recording channels start recording when they detect signal above the level set by the VOX level and stop recording when they detect signal below the VOX level, but after a user configurable grace period of seconds.

- Manual – manual on/off recording control.

The manual trigger allows third party applications to control recording over the Total Recall VR Remote Manager Interface.

- Off – recording trigger disabled, no recording possible on channel.

Recommended setting for all analogue channels that are NOT connected to an analogue audio source or an analogue telephone line. As an alternative, use this setting to temporarily or permanently disable recording on channels.

Specification:

- RJ11C/RJ12/RJ14 (6P6C) connector – 2 channels per connector.
- Interface based on the CPC5710N chip, PC357N photo-coupler and the P2769 pick-off transformer providing high-impedance input and high (>40dB) common mode rejection ratio.
- Caller ID detection: FSKR and DTMF.
- Digit detection: DTMF. Channel (on, off) selectable.
- Ring detection.
- Automatic gain control.
- Encoding method: HQVQ, 8000Hz, 7.9Kbps, mono.
- Beep tone: 1.4KHz, channel and level (off, -30dBm, -24dBm, -18dBm) selectable.

Approvals:

- AS/NZS 60950.1:2003 INCL AMDT 1 Safety of information technology equipment
- IEC 60950-1 Information technology equipment – Safety
- EN 60950-1 Information technology equipment – Safety
- AS/ACIF S002:2005 Analogue interworking and non-interference requirements for Customer Equipment for connection to the Public Switched Telephone Network
- TBR 21 Terminal Equipment (TE); Attachment requirements for pan-European approval for connection to the analogue Public Switched Telephone Networks (PSTNs) of TE (excluding TE supporting the voice telephony service) in which network addressing, if provided, is by means of Dual Tone Multi Frequency (DTMF) signalling
- PTC 200:2006 Requirements for Connection of Customer Equipment to Analogue Lines
- ANSI/TIA-968-A:2007 Technical Requirements for Connection of Terminal Equipment to the Telephone Network
- TIA-1096-A Connector Requirements for Connection of Terminal Equipment to the Telephone Network

4.2. VoIP Recording Channels

Total Recall VR has two types of VoIP recording channels: passive and active.

4.2.1. Passive VoIP Recording Channels

Total Recall VR uses a software based VoIP packet collector capable of detecting and collecting SIP, H.323 and RTP packets on IP networks. The packet collector uses one of the system LAN interfaces to detect and collect such packets.

This interface does not interact with the packets on the network in any way. It does not add, remove or modify packets. It simply detects and takes a copy of each packet.

Recording trigger:

- SIP session (call).
- H.323 call.
- Unicast RTP stream.
- Multicast RTP stream.

Specification:

- RJ45 (8P8C) connector.
- SIP over UDP (RFC3261, RFC2976, RFC2833).
- SDP (RFC3264).
- H.323 over UDP or TCP (ITU-T H.323, ITU-T H.225, ITU-T H.245).
- RTP (RFC 3550).
- Encoding method: G.711 (A or μ -law), 8000Hz, 64Kbps, mono.

To achieve best results with this interface observe the following:

1. Configure end-points and the telephone system to use the G.711 (A or μ -law) codec during calls.
2. Disable silence suppression.
3. If SDP messages do not specify the 'ptime' parameter, then make sure each RTP packet carries exactly 20ms of audio (or 160 audio signal samples).
4. Make sure all endpoints and the telephone system use the same 'ptime'.
5. Do not use SIP encryption.
6. Do not use RTP encryption.

4.2.2. Active VoIP Recording Channels

Total Recall VR is capable of recording SIP sessions (calls) and raw unicast and multicast RTP streams in active mode.

SIP Sessions

Total Recall VR can act as a SIP Media Server and accept SIP session request from other equipment, such as SIP telephone systems, radio consoles and base stations, for the purpose of recording audio.

This interface is capable of receiving RTP packets during SIP sessions. It does not send RTP packets during SIP sessions.

Recording trigger:

- SIP session (call).

Specification:

- RJ45 (8P8C) connector.
- SIP over UDP (RFC3261, RFC2976, RFC2833).
- SDP (RFC3264).
- RTP (RFC 3550).
- Encoding method: G.711 (A or μ -law), 8000Hz, 64Kbps, mono.

To achieve best results with this interface observe the following:

1. Configure end-points and the PBX to use the G.711 (A or μ -law) codec during calls.
2. Disable silence suppression.
3. If SDP messages do not specify the 'ptime' parameter, then make sure each RTP packet carries exactly 20ms of audio (or 160 audio signal samples).
4. Make sure all endpoints and the telephone system use the same 'ptime'.
5. Do not use SIP encryption.
6. Do not use RTP encryption.

Raw RTP Streams

Total Recall VR is capable of receiving RTP packets on user specified UDP ports on one, or simultaneously on both of its system LAN interfaces.

This interface receives RTP packets only. It does not send packets, RTP or any other type, on the network.

It is possible to record a single RTP stream, for example all Tx RTP packets from a RoIP endpoint, or all the Rx packets. In this case Total Recall VR stores each RTP stream as a separate recording.

In addition, it is possible to record a pair of RTP streams, for example the Tx and Rx RTP streams from and to a RoIP endpoint. In this case, Total Recall VR will mix the audio that it receives and store it as a single recording.

Recording trigger:

- Unicast or multicast RTP stream.

Recording starts when the first RTP packet arrives. Recording stops when no RTP packets arrive for a user specified time (VoX like function).

- Tait VRP call.

Specification:

- RJ45 (8P8C) connector.
- RTP (RFC 3550).
- Tait VRP.
- Omnitronics RoIP.
- Hytera RoIP.
- Encoding method:
 - G.711 (A or μ -law), 8000Hz, 64Kbps, mono.
 - AMBE, 8000Hz, 2450bps, mono (Tait VRP only).

4.3. ISDN Recording Channels

Total Recall VR uses a purpose built, high-impedance, ISDN PRI link (E1 or T1) tapping card to capture signalling and audio on ISDN PRI links.

This interface does not interact with the calls and audio on links in any way.

Recording trigger:

- Q.931 calls on the D channel.

Specification:

- RJ45 (8P8C) connectors.
- ISDN protocols: ITU-T Q.931, National ISDN 1 and 2, Nortel DMS 100, AT&T 4ESS, Lucent 5ESS, Euro ISDN.
- Encoding method: G.711 (A or μ -law), 8000Hz, 64Kbps, mono.

Approvals:

- AS/NZS 60950.1:2003 INCL AMDT 1 Safety of information technology equipment
- IEC 60950-1 Information technology equipment – Safety
- AS/ACIF S016:2001 Requirements for Customer Equipment for connection to hierarchical digital interfaces
- TIA-968-A Technical Requirements for Connection of Terminal Equipment to the Telephone Network
- TIA-1096-A Connector Requirements for Connection of Terminal Equipment to the Telephone Network

5. Deployment Concepts

An understanding of a number of concepts related to deploying audio, call and/or radio recording solutions is a prerequisite for successful deployment of a Total Recall VR in any environment.

5.1. Passive Recording

Passive recording equipment is completely transparent to existing telephone and radio communication systems and the way they are used. The recorder is a separate device to the telephone and radio communication system and connects to telephone and radio communication lines via what is known as a “high-impedance tap” in order to capture call information and audio. There is no need to modify existing telephone and radio communication system equipment in any way.



Total Recall VR is a passive recording system that is capable of recording audio in a passive way in analogue, VoIP and ISDN environments.

Passive call recording equipment does not interact with telephone calls and radio communication in any way. As a matter of fact, the users of the telephone and radio communication system will not even know that it exists. With most passive recording equipment it is possible to control recording (start, stop, pause ...) during calls by entering a pre-defined sequence of digits on the telephone key-pad, or by deploying a separate application on desktops.

5.2. Active Recording

Active call recording equipment is never transparent to existing telephone and radio communication systems. However, just like passive recording equipment, it can be completely transparent to the way users use the telephone and radio communication system.



Total Recall VR is active recording system that is capable of recording SIP sessions and raw RTP streams in VoIP, RoIP and AoIP environments.

5.2.1. Active Call Recording

Unlike passive recording equipment, the telephone system may have to be modified or upgraded to support what is known as Computer Telephony Integration (CTI). In addition to the CTI function, the telephone system may need additional telephone

lines which will be used to connect the call recording equipment to the telephone system.

Active recording equipment needs the CTI function and the telephone lines between the telephone system and itself in order to capture call information and conversations.

Active recording equipment always interacts with calls. However, this interaction can be transparent to the way users make calls as it occurs in the background between the telephone system and the recorder. As with passive recording, with most active recording equipment it is possible to control recording (start, stop, pause ...) during calls by entering a pre-defined sequence of digits on the telephone key-pad, or by deploying a separate application on desktops.

On the other hand, the interaction can be fully non-transparent. In this case, one of the call participants needs to “invite” or “add” the recorder to the call. This is usually done by pre-programming a button on handsets which (in the background) conferences the recording equipment with an active call.

Note that in all cases, the call recording equipment is an active participant in calls. This has its advantages, for example the recording equipment can play announcements during conversations. This is not possible with passive recording equipment.

5.2.2. Active Radio Recording

An active recorder can be integrated with most radio communication systems. However, in most cases the recorder must have support for what is usually a proprietary protocol which is used by the radio communication system to send audio and call information to the recorder.

5.3. Extension Side Recording

Extension side recording is a method of recording telephone calls by tapping the lines between the telephone system and the desk phones within the enterprise.

The subsequent figure shows an example of extension side recording where a Total Recall VR taps the telephone lines between the telephone system (PBX) and the desk phones in order to capture call information and audio.

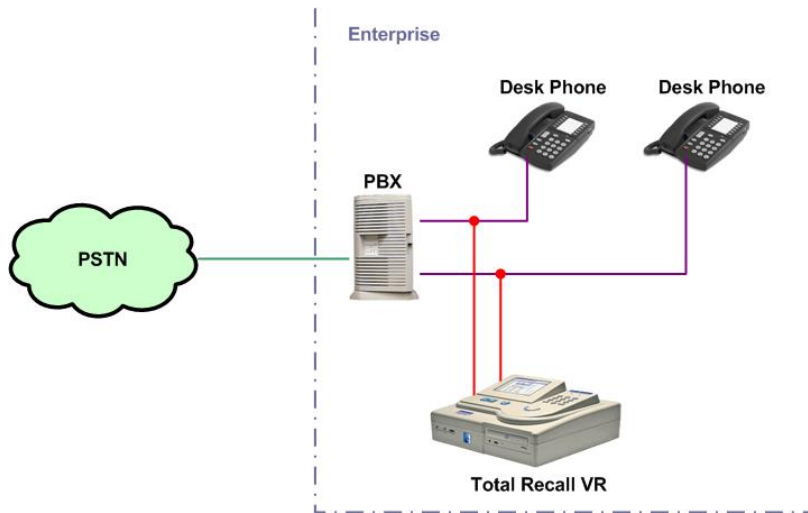

Figure 1: Extension Side Recording

Total Recall VR can easily determine extension numbers from the call information that it detects when used to record calls on the extension side. Both the telephone system and the Total Recall VR will work independently of each other and do not need to exchange additional information about calls.

5.4. Trunk Side Recording

Trunk side recording is a method of recording telephone calls by tapping the lines between the Central Office (CO) and the telephone system.

The subsequent figure shows an example of trunk side recording where a Total Recall VR taps the telephone lines between the CO and the telephone system (PBX) in order to capture call information and conversations.

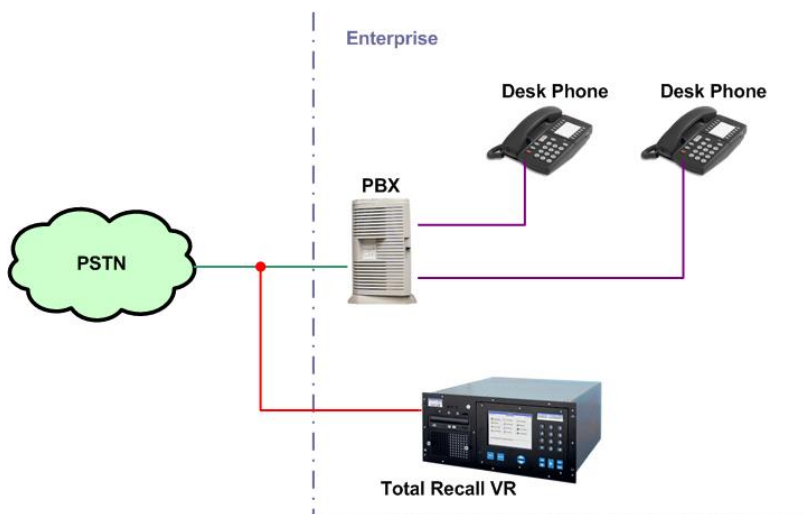

Figure 2: Trunk Side Recording

Total Recall VR is not able to determine extension numbers from the call information that it detects when used to record calls on the trunk side without receiving additional information from the telephone system (see section 5.5 SMDR Integration).



Extension numbers do not appear in the call information on the trunk side of the call. The telephone network uses Full National Numbers (FNN) in the call information instead.

However, additional information from the telephone system may not be required if the enterprise is using DID numbers (see 21 Direct Inward Dial Numbers). Total Recall VR has an Extension Mapping configuration which can be used to map DID numbers to extension numbers, thus avoiding the need for additional information from the telephone system.

5.5. SMDR Integration

SMDR integration is a method of receiving additional information, in the form of Station Management Detail Records (SMDRs), from a telephone system about each call that the telephone system handles.

SMDRs are generally used for call accounting purposes, however they contain information, in particular extension numbers, which are useful to call recording systems such as Total Recall VR.

One of the difficulties when using any passive call recording system in Trunk Side Recording scenarios (see section 5.4) is determining extension numbers for recorded calls.

Total Recall VR solves this problem in two different ways which can be used independently or in combination:

1. It can accept Station Management Detail Records (SMDRs) from the telephone system, extract extension numbers from the SMDRs and then assign them to recorded calls.
2. It provides powerful Extension Mapping configuration which can be used to convert DID numbers (see section 5.6 Direct Inward Dial Numbers) to extension numbers.

Total Recall VR can accept SMDRs from a telephone system on its LAN interfaces using the TCP or UDP protocol as shown on the subsequent figure.

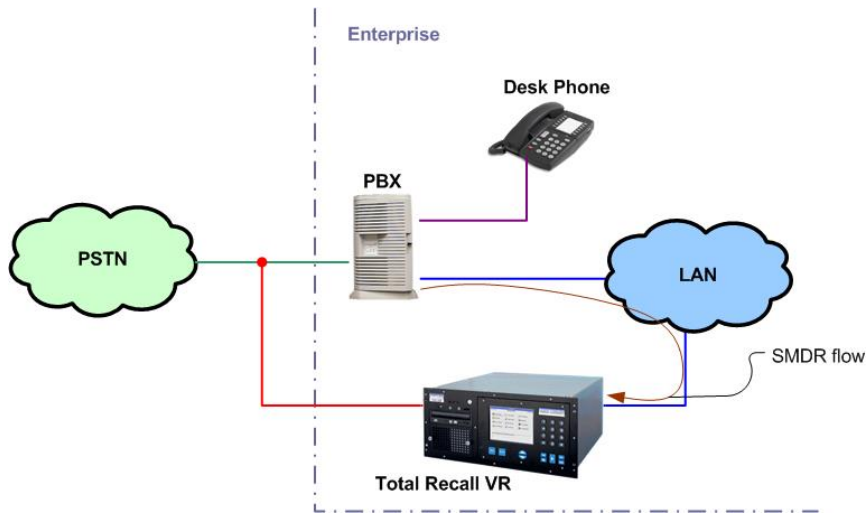

Figure 3: SMDR Integration

Some telephone systems have a serial interface instead of an Ethernet interface for SMDR integration. If this is the case, then it is mandatory to use a Serial Device Server (which acts as a serial to IP protocol converter).

Most telephone system can send SMDRs to only one external device. If this is the case, and if SMDRs are already being sent to a call accounting application, then it is mandatory to use the Prolancer IP Packet Multicaster to send copies of the SMDRs to multiple devices as shown on the subsequent figure.

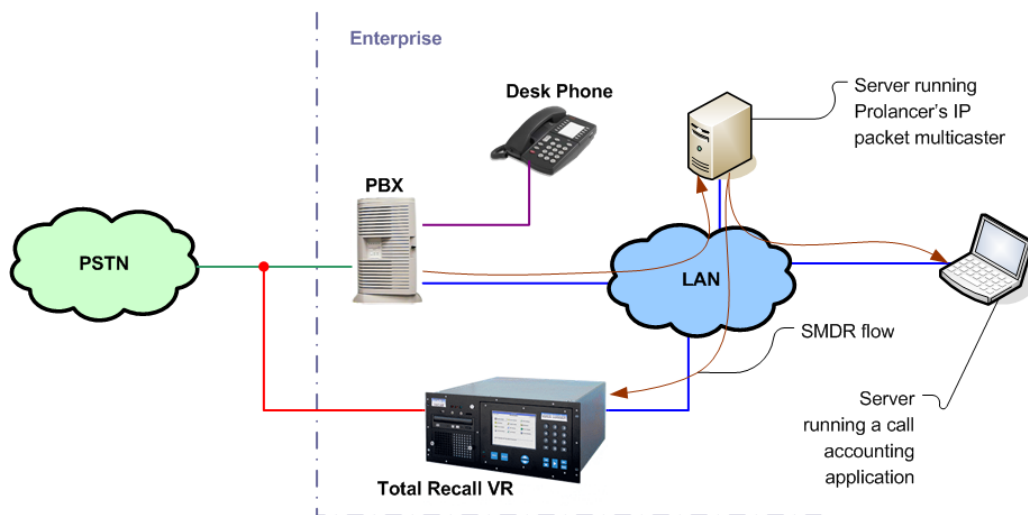

Figure 4: SMDR Integration with IP Packet Multicaster

At this stage Total Recall VR can accept and process SMDRs from the following telephone systems:

- Avaya IP Office v4.2+
- Panasonic KX-TDA100 and KX-TDA200

- Samsung iDCS-500
- Siemens HiPath 3000/5000
- Asterisk

5.6. Direct Inward Dial Numbers

Direct Inward Dial (DID) numbers is a service provided by telephone companies that allows enterprises to have numerous individual Full National Numbers (FNNs), typically one per desk phone.

If an enterprise has this service, then the telephone system can be configured to route calls to FNNs directly to extensions associated with desk phones.

One of the difficulties when using any passive call recording system in Trunk Side Recording scenarios (see section 5.4) is determining extension numbers for recorded calls.

Total Recall VR solves this problem in two different ways which can be used independently or in combination:

1. It can accept Station Management Detail Records (SMDRs) from the telephone system, extract extension numbers from the SMDRs (see section 5.5 SMDR Integration) and then assign them to recorded calls.
2. It provides powerful Extension Mapping configuration which can be used to convert DID numbers to extension numbers.

Total Recall VR can automatically convert DID numbers to extension numbers by using information in its Extension Mapping configuration. The Extension Mapping configuration captures the mapping between DID numbers and extension numbers.

A DID service in combination with the Total Recall VR Extension Mapping configuration eliminates the need for SMDR integration (see section 5.5) between the telephone system and Total Recall VR. In most cases this makes the whole deployment more affordable as most telephone system require additional licenses for SMDR generation and IP network connectivity.

5.7. Total Recall VR Extensions

Total Recall VR Extensions are a Total Recall VR concept and should not be confused with telephone system extension numbers which are used for desk phones (or mobile devices) within an enterprise.

Total Recall VR Extensions are one of the three different identifiers that can be assigned to the source and the destination of recordings, irrespective of whether the recordings are of a telephone call or another audio source (such as radios for example).

The other two identifiers are the Total Recall VR Raw and the Total Recall VR Mapped Numbers which do not have the same effect as the Total Recall VR Extensions to the availability of various features.

As identifiers, Total Recall VR Extensions are fundamental to most Total Recall VR features and if not present for a recording, then most features will not work at all for that recording.



For example, it will not be possible to find recordings by using the 'Extension' search criteria.

In addition, most of the Total Recall VR client applications will work with reduced functionality (or not at all in the case of the RoD Client application) without Total Recall VR Extensions.

Total Recall VR can classify calling and called numbers (or telephone system extensions) as Total Recall VR Extensions when recording calls. As a matter of fact in most deployments telephone system extensions map directly to Total Recall VR Extensions.

However, depending on Total Recall VR configuration, Total Recall VR Extensions can be any free text identifiers. For example, Total Recall VR Extension "Tanya's Desk Phone" can represent actual telephone system extension 100, while "Tanya's Softphone" can represent (the human form of) telephone system extension 200 (which the telephone system may know as "sip:ext200@myenterprise.com").

Total Recall VR Extensions may (and should) be used on deployments where Total Recall VR is used to record audio sources other than telephone calls. For example Total Recall VR Extension "2Day FM" can be assigned to recordings created on an analogue recording channel which is used to log the radio program from a radio station called 2Day FM.

Total Recall VR uses information that it extracts from call signalling and its configuration to determine Total Recall VR Extensions for recordings. Here is a summary of the steps used by Total Recall VR to determine Total Recall VR Extensions for recordings:

1. Total Recall VR starts with Raw identifiers which it collects from call signalling or determines from its configuration. The following table shows the Raw identifiers for various recording scenarios:

When recording ...	Raw identifiers are ...
Analogue telephone call (outgoing)	Dialled DTMF digits and the 'Extension' value, which appears in the configuration for each analogue recording channel.
Analogue telephone call (incoming)	Incoming CLI digits and the 'Extension' value, which appears in the configuration for each analogue recording channel.
SIP call	Values in the 'From' and 'To' header fields in the 200 response to the INVITE message.

H.323 call	Values in the ‘Calling Party Number’ and ‘Called Party Number’ information elements, if present, which appear in the SETUP message. The previous will be replaced with the first alias that appear in the ‘sourceAddress’ and ‘destinationAddress’ elements, if present, which appear in the ‘User to User’ information element of the SETUP message.
RTP Endpoint (passive)	<IP address:Tx port> or <IP address:Rx port> which appear in the RTP Endpoint configuration.
RTP Stream (active)	<From IP address:From UDP port> which appear in the RTP packets and <IP address: UDP port> which appear in the RTP Stream configuration.
RTP Stream Pair (active)	<Tx From IP address:From UDP port>;<Rx From IP address:From UDP port> which appear in the RTP packets and <Tx IP address: UDP port>;<Rx IP address: UDP port> which appear in the RTP Stream configuration.
VRP call	MPT 1327 address or MPT 1343 number.

- Total Recall VR then converts the Raw identifiers to Total Recall VR Mapped identifiers by applying identifier conversion rules that are present in the Signalling Mapping configuration to each of the Raw identifiers.

The mapping rules are regular expressions which specify how to convert Raw identifiers to Mapped identifiers. For example, a mapping rule can convert the Raw identifier “sip:ext200@myenterprise.com” to Mapped identifier “Extension 200”

- Finally, Total Recall VR attempts to match Mapped identifiers to matching rules that are present in the Internal Dial Plan configuration and if, and only if, it finds a rule that matches a Mapped identifier, then it classifies that identifier as a Total Recall VR Extension.

Continuing from the previous example, if the Internal Dial Plan configuration has an entry that matches the Mapped identifier “Extension 200”, then, and only then, the identifier “Extension 200” will be classified as a Total Recall VR Extension.

5.8. Total Recall VR Recording Policies

Total Recall VR recording policies are a Total Recall VR configuration which controls the method of recording which can be:

- Record by default - Total Recall VR will automatically record all audio sources and telephone calls and keep recordings unless instructed otherwise during recording.

- Don't record by default - Total Recall VR will automatically record all audio sources and telephone calls, but at the end of the recording it automatically discards recordings unless instructed otherwise during recording.
- Record partial calls – Total Recall VR will record only parts of all audio sources and telephone calls, as instructed during recording, and keep all parts concatenated in a single recording.

In addition to the method of recording, policies specify whether real-time monitoring is allowed or not while recording is in progress.

Policies can be one of two types:

- Global – a single system wide policy which applies to recordings from all audio sources and telephone calls on all recording channels.
- Extension – apply only to recordings from audio sources and telephone calls which have been assigned Total Recall VR Extension identifiers. These policies have precedence over the global policy.



Total Recall VR Recording Policies depend on Total Recall VR Extension identifiers. See section 5.3 Extension Side Recording for more information.

Recording policies are useful in a number of ways. For example, policies can be used to:

1. Selectively record (or not) telephone calls to specific telephones.
2. Decide in real-time, while recording, whether to keep a recording of important conversations.
3. Control access to real-time monitoring (listen in) during recording.
4. Allow remote client applications to control (start, stop ...) recording.

6. Passive VoIP Recording

6.1. Overview

Total Recall VR uses a software based VoIP packet collector which is capable of detecting, extracting and then processing SIP, H.323 and RTP packets when connected to an Ethernet link.

The packet collector does not interact with the packets on the Ethernet link in any way. It does not add, remove or modify packets. It simply detects and takes a copy of each packet for further processing.

Each Total Recall VR is equipped with a single VoIP packet collector capable of collecting VoIP packets from a single Ethernet link. A separate appliance, Total Recall VR Traffic Collector, enables Total Recall VR to collect packets from up to four Ethernet links.

6.2. Interface

Total Recall VR uses one of its two LAN interfaces to collect VoIP packets. The configuration of the VoIP packet collector specifies which LAN interface.

Traffic Collector uses up to four of its LAN interfaces to collect VoIP packets. It also uses one of the four LAN interfaces to send packets that it collects to one of up to four Total Recall VRs.

The Total Recall VR Classic Desktop has a single LAN interface: LAN 1. As a result, this is the interface that the packet collector will use, if activated. Note that the system will use the same interface for other network communication, for example communication with Remote Manager. This does not interfere with the operation of the packet collector.

All other models have two LAN interfaces: LAN 1 and LAN 2. It is recommended to configure the packet collector to use the LAN 2 interface on these models. This leaves the LAN 1 interface free to use for all other network communication, for example communication with Remote Manager.

6.3. Supported Protocols

Total Recall VR supports the following protocols and media codecs when recording in passive mode:

- SIP over UDP (RFC3261, RFC2976, RFC2833).
- SDP (RFC3264).
- H.323 over UDP or TCP (ITU-T H.323, ITU-T H.225, ITU-T H.245).
- RTP (RFC 3550).
- Encoding method: G.711 (A or μ -law), 8000Hz, 64Kbps, mono.

6.4. Deployment Rules

The following rules apply when deploying a Total Recall VR on a VoIP network in passive recording mode:

1. All end-points and the telephone system must use the G.711 (A or μ -law) codec during calls.
2. Silence suppression must be disabled.
3. If SDP messages do not specify the 'ptime' parameter, then each RTP packet must carry exactly 20ms of audio (or 160 audio signal samples).
4. All endpoints and the telephone system must use the same 'ptime'.
5. SIP encryption must be disabled.
6. RTP encryption must be disabled.

6.5. VoIP Extensions

Section 5.7 Total Recall VR Extensions explained the importance of Total Recall VR Extensions to the operation of Total Recall VR.

Total Recall VR uses calling and called party identifiers as a starting point (or Raw identifiers) in the process of determining Total Recall VR Extensions for calls on VoIP networks.

For SIP networks it uses the values of the "From" and "To" header fields in the 200 response to the INVITE message. For example, Total Recall VR will use "sip:alice@atlanta.example.com" and "sip:bob@biloxi.example.com" as Raw identifiers if it receives the subsequent message:

```
1. SIP/2.0 200 OK
2. Via: SIP/2.0/TCP client.atlanta.example.com:5060;branch=z9hG4bK74bf9
3. From: Alice <sip:alice@atlanta.example.com>;tag=9fxced76sl
4. To: Bob <sip:bob@biloxi.example.com>;tag=8321234356
5. Call-ID: 3848276298220188511@atlanta.example.com
6. CSeq: 1 INVITE
7. Contact: <sip:bob@client.biloxi.example.com;transport=tcp>
```

For H.323 networks Total Recall VR first extracts the values in the 'Calling Party Number' and 'Called Party Number' information elements, if present, which appear in the SETUP message. Then it replaces these with the first alias that appear in the 'sourceAddress' and 'destinationAddress' elements, if present, which appear in the 'User to User' information element of the SETUP message.

The Raw identifiers then go through the mapping process explained in section 5.7 to determine first Mapped identifiers and then Extensions.

6.6. Packet Capture Methods

Total Recall VR must be deployed in such a way so that all SIP, H.323 and RTP packets for VoIP calls that should be recorded are presented to the LAN interface that is used by the VoIP packet collector.

There are a number of ways to achieve this.

6.6.1. Ethernet Hub



Ethernet hubs are devices which connect multiple Ethernet devices together and make them act as a single network segment.

Hubs have multiple ports. An important aspect of their operation is how they distribute copies of Ethernet frames to ports. Namely, a frame that is introduced on one port is simply replicated to all other ports. This makes them ideal for presenting VoIP packets to the Total Recall VR interface.

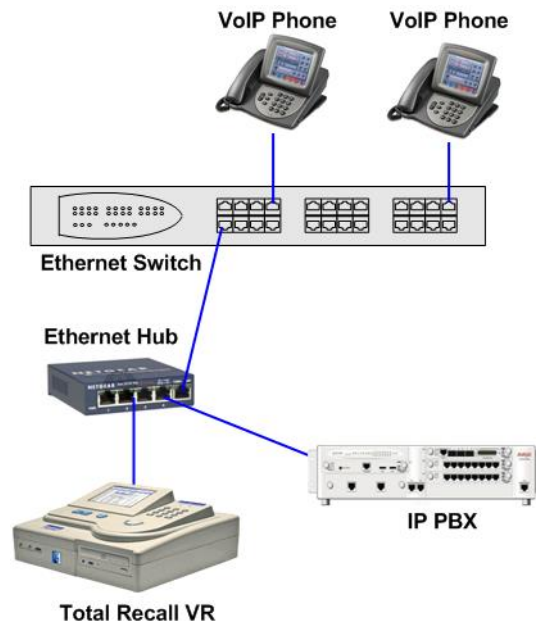

Figure 5: Ethernet Hub as a Link Tapping Device

Unfortunately, hubs are becoming harder and harder to purchase. As a result, hubs are being replaced by Ethernet link taps.

6.6.2. Aggregating Ethernet Tap



Aggregating Ethernet link taps are becoming very popular now that Ethernet hubs are almost extinct.

They are plug-and-play devices with 3 ports: 2 used to tap an Ethernet link while the remaining port acts as a monitoring port. The tap simply copies all packets that appear on the Ethernet link to the monitoring port when connected across an Ethernet link.

As a result, a Total Recall VR can receive all VoIP packets that appear on an Ethernet link if connected to the monitoring port of the tap.

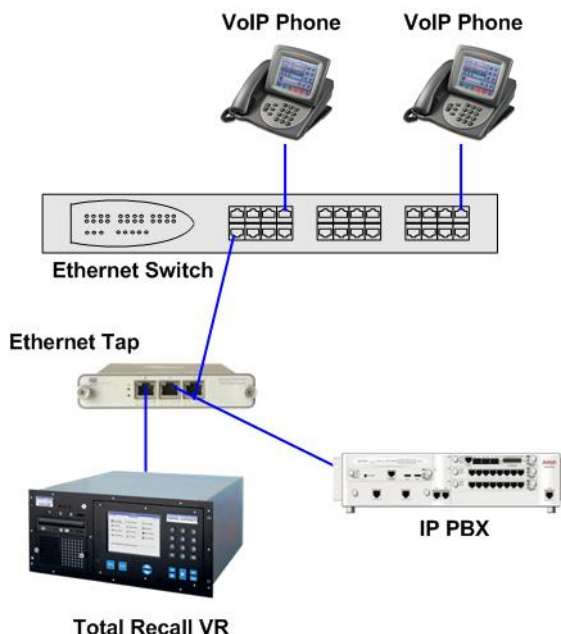

Figure 6: Ethernet Link Tap as a Link Tapping Device

One disadvantage of the Ethernet link taps is their price. They cost hundreds of dollars. However, most offer internal memory buffers for zero packet loss and zero copy delay when extracting packets from the Ethernet link and presenting them to the monitoring port.

6.6.3. SPAN Port

Switch Port Analyser (SPAN) port is a feature of most modern Ethernet switches. It was introduced to connect network monitoring and troubleshooting devices to Ethernet switches.

SPAN ports are used for port mirroring where the packets that appear on one switch port are blindly presented to another port (the SPAN port) bypassing the standard Ethernet switch logic which decides which ports to send packets to.



SPAN ports are also known as Roving Analysis Ports (RAP), or simply mirror ports.

SPAN ports are by far the cheapest way to connect a Total Recall VR to a VoIP network for the purpose of recording. Even if the current switch on-site does not support it, myriad other switches which cost few hundred dollars do.

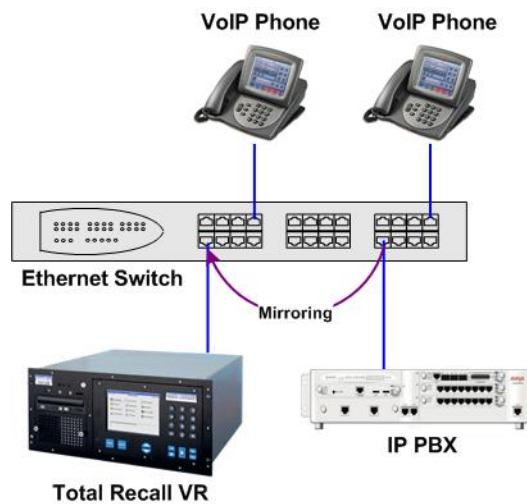

Figure 7: SPAN Port as a Link Tapping Device

But, as the saying goes “You get what you pay for”, beware of the limitations of SPAN ports when deploying Total Recall VR on networks where 20 or more simultaneous VoIP calls need to be recorded:

1. Spanning changes the timing of frame interaction. As a result recording time stamps may be as much as a second late.
2. The spanning function is not the primary switch function. So if replicating a frame becomes an issue, the switch will drop it in order to allocate resources to the switching function. Dropped frames do not appear on the Total Recall VR LAN interface that is connected to the SPAN port and as a result they will not be processed by Total Recall VR.
3. If the SPAN port gets overloaded, which can easily be done by mirroring a number of switch ports to a single SPAN port, then the switch will drop frames on the SPAN port. Dropped frames do not appear on the Total Recall VR LAN interface that is connected to the SPAN port and as a result they will not be processed by Total Recall VR.
4. SPAN ports drop all Ethernet frames that are corrupt and those that are below a specified minimum length.



Use an Aggregating Ethernet Link Tap (see section 6.6.2) in scenarios where 20 or more VoIP calls must be recorded at the same time for reliable VoIP call recording.

This is not a limitation of Total Recall VR. Rather, it is a limitation of Ethernet switches.

6.6.4. Traffic Collector



All previous packet capture methods show how to collect packets on a single Ethernet link. However, in many cases it is necessary to collect packets from multiple links in order to record VoIP calls.

The Total Recall VR Traffic Collector is a high performance VoIP packet capture appliance which, when strategically placed on a network, can capture VoIP packets and send them to one or more Total Recall VRs.

It eliminates the need for multiple Total Recall VRs on complex VoIP networks.

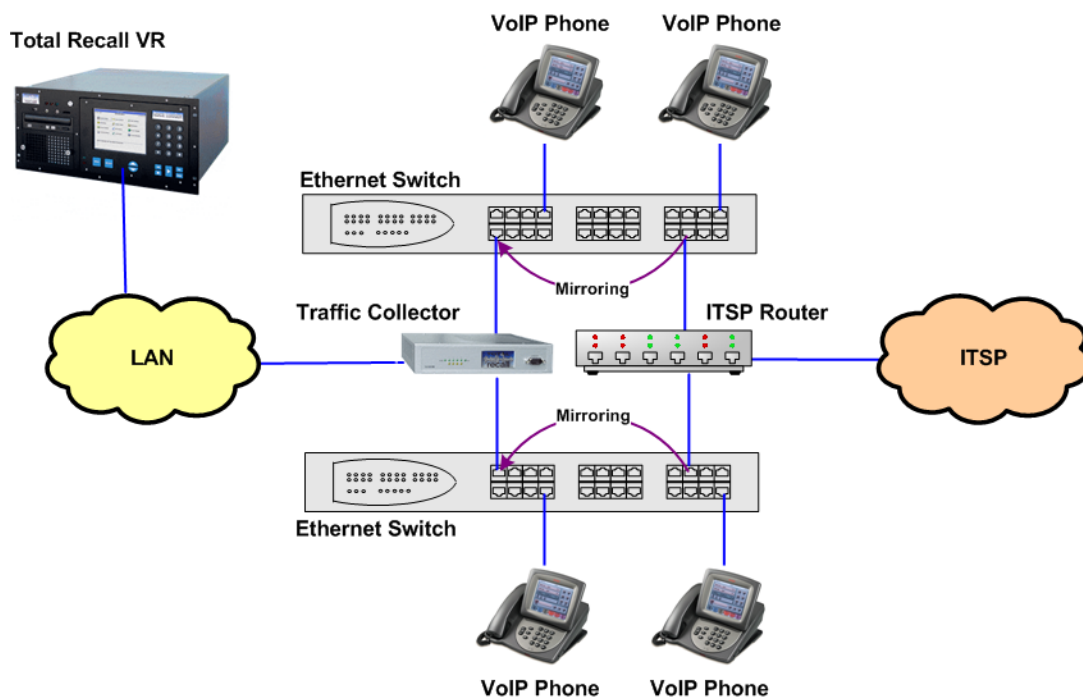

Figure 8: Traffic Collector as a Link Tapping Device

Note that the Traffic Collector depends on one of the other link tapping technologies (see sections 6.6.1, 6.6.2 and 6.6.3) to present packets to its LAN interfaces (the prior diagram shows the use of SPAN ports for example). However, a single device can collect packets from four different Ethernet links on the enterprise network.

Traffic Collectors use a proprietary protocol over TCP, or UDP, to send collected packets to Total Recall VRs for processing.

6.7. Deployment Scenarios

It is important to identify the correct Ethernet link, or links, on a VoIP network to tap in order to successfully deploy Total Recall VR to record VoIP calls.

In this section we look at a number of VoIP deployments and focus on the different routes that VoIP packets can take in a VoIP network.



The diagrams in this section use green and red lines to show logical flow of VoIP packets, rather than the actual physical route that packets take.

For example, in the subsequent diagram (Figure 9), the signalling and voice packets actually pass through the Ethernet switch, even though that is not what is explicitly shown.

6.7.1. Simple VoIP Networks

Simple VoIP network featuring a single telephone system and a small number of VoIP telephones that are connected to a single Ethernet switch are very common.

In most cases the signalling (SIP or H.323) and media (RTP) packets will be present on the link between the telephone system and the Ethernet switch. As a result, the same link is the obvious tapping point. This is shown on the subsequent diagram.

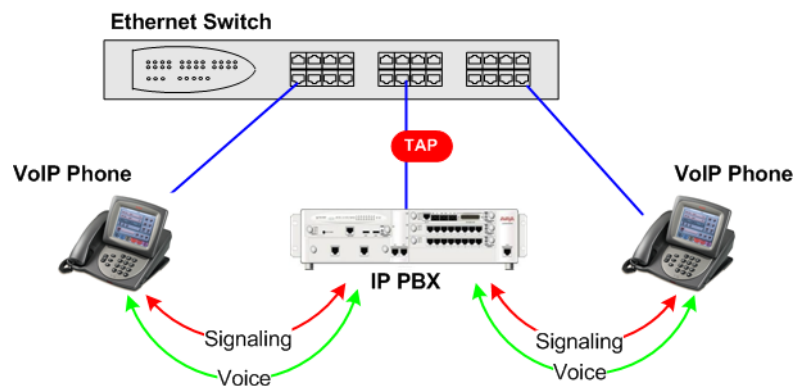

Figure 9: All Packets Pass through the Telephone System

However, beware of telephone systems that shuffle the media packet flow to free up media processing resources.

Media shuffling is a method of freeing resources, and in particular media processing resources, on the telephone system when it is not necessary for media packets to pass through the telephone system during calls. At call start all packets pass through the telephone system as shown on the previous diagram. However, soon after the start of the call the telephone system instructs the end-points involved in a call to send media packets directly to each other as shown on the subsequent diagram. In addition, the telephone system can instruct the end-points to send media packets back to it at any time during the call.

In this case it is mandatory to tap all end-point links in order to record VoIP calls as shown on the subsequent diagram.

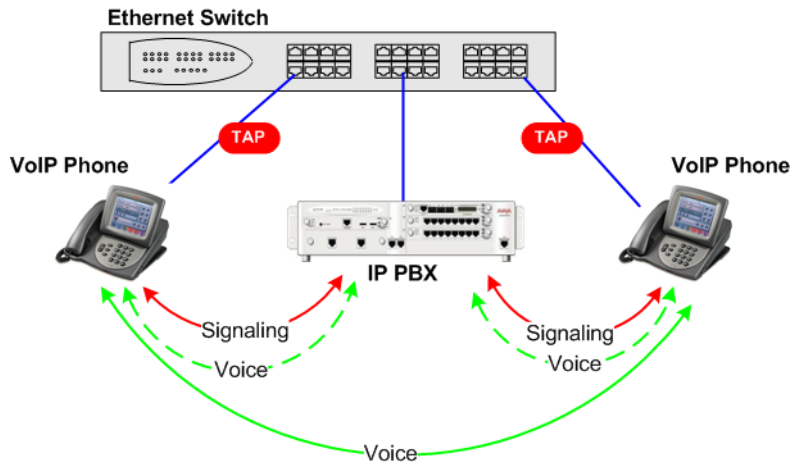

Figure 10: Media Shuffling

In contrast, in some cases only the signalling packets are present on the link between the telephone system and the Ethernet switch. Media packets do not appear on this link at all as shown on the subsequent figure.

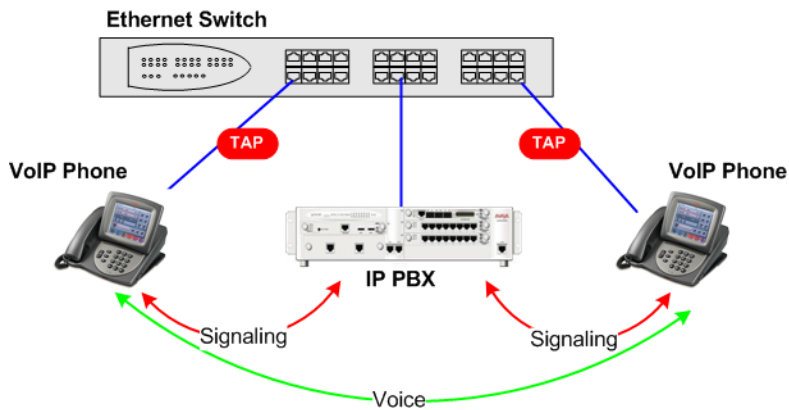

Figure 11: Only Signalling Packets through the Telephone System

In this case it is mandatory to tap all end-point links, as shown on the previous diagram in order to record VoIP calls.

Previous diagrams show the packet flow for internal calls. Packets for external calls always pass through the link that connects a Media Gateway (which can be the telephone system itself) to an Ethernet switch as shown on the subsequent figure.

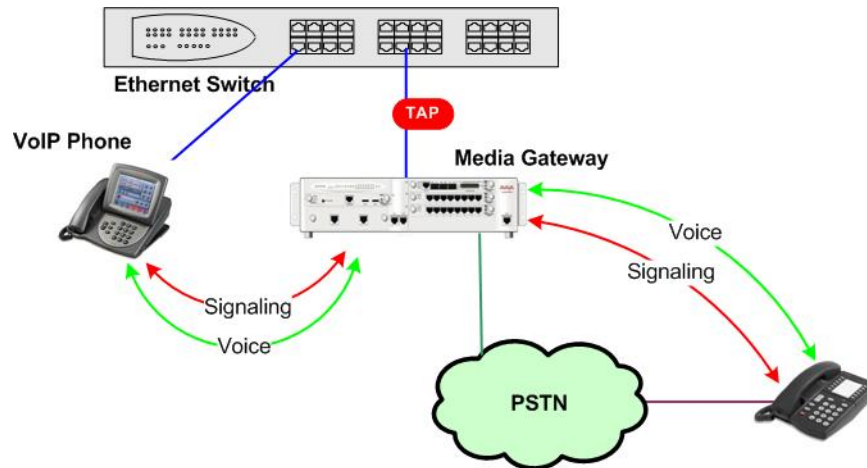

Figure 12: Packet Flow for External Calls

As a result, a tap on the link that connects the Media Gateway to an Ethernet switch is sufficient to record all outgoing and incoming calls as shown on the previous diagram.

6.7.2. Peer-to-peer VoIP Networks

Peer-to-peer SIP (P2PSIP) networks do not use a telephone system. Instead such networks leverage the distributed nature of P2P for distributed resource discovery, thus eliminating the need for a centralised telephone system.



See <http://www.p2psip.org/> for more details on P2PSIP.

The signalling and media packets flow directly between end-points on such networks as shown on the subsequent diagram.

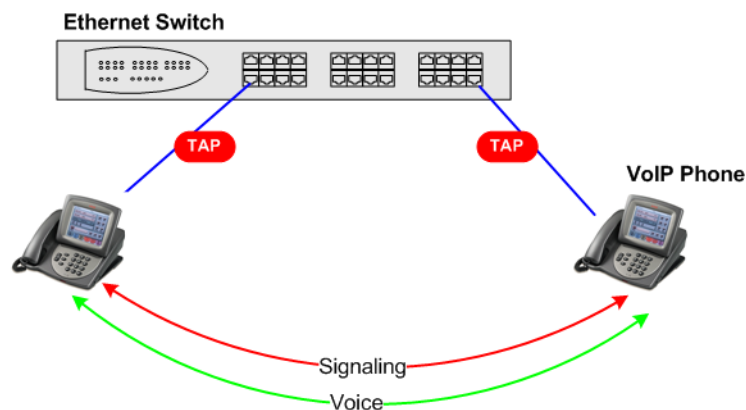

Figure 13: Packet Flow on P2PSIP Networks

So it is mandatory to tap all end-point links as shown on the previous diagram in order to record VoIP calls on P2PSIP networks.

6.7.3. Hosted VoIP Networks

The number of hosted VoIP solutions increased dramatically over the past years. New businesses are opting for hosted VoIP solution when it is time to replace legacy telephone system equipment more often than ever. As a result Total Recall VR is, and will be, deployed in organisations with hosted VoIP solution more often.

An interesting aspect of hosted VoIP solutions is that all signalling and media packets always travel to the hosted VoIP service provider. This may appear unusual at first for internal calls (after all, why send all media packets to the VoIP service provider and back). However, it is necessary as it enables the service providers to offer a range of services which it cannot if the media packets do not travel through its equipment.

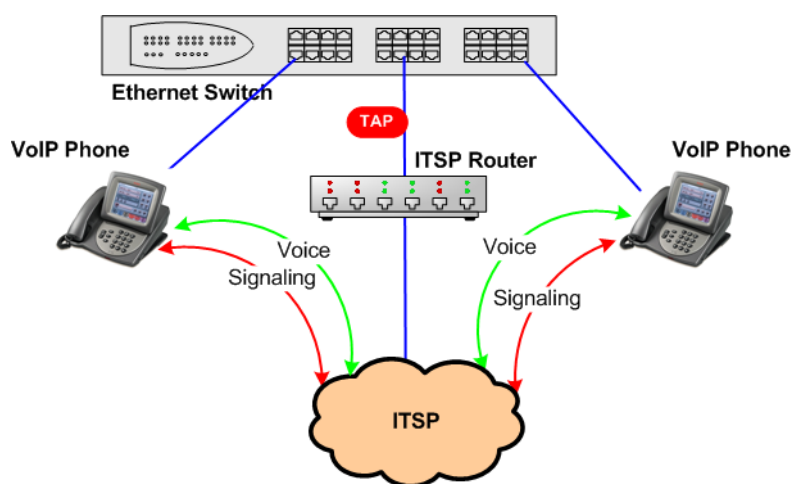

Figure 14: Internal Call Packet Flow

This ‘oddity’ is an advantage when it comes to recording VoIP calls. It is only necessary to tap the link that connects the VoIP service provider router (a.k.a. ITSP router) to the Ethernet switch inside the organisation in order to record all internal VoIP calls as shown on the previous diagram.



Avoid tapping the link between the ITSP router and the ITSP network. VoIP and other packets may be encrypted on this link as VoIP providers use Virtual Private Networks (VPNs) to connect customer sites to their network.

It is important to recognise that technologies (such as STUN and ICE) exist which enable end points to send media packets directly to each other on this type of networks as shown on the subsequent diagram.

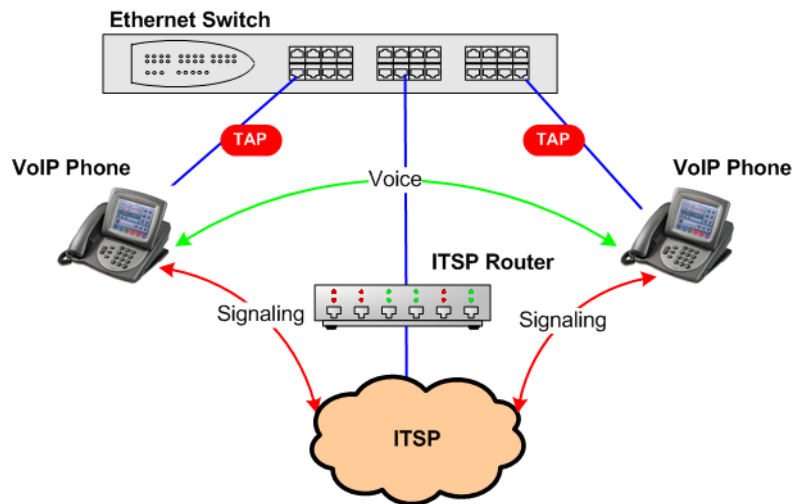

Figure 15: Direct Media Packet Flow

If this is the case, then it is necessary to tap all end-point links to record VoIP calls as shown on the previous diagram.

All external calls will be recorded by tapping the link that connects the VoIP service provider router to the Ethernet switch inside the organisation as all VoIP packets for external calls are always sent to the VoIP service provider.

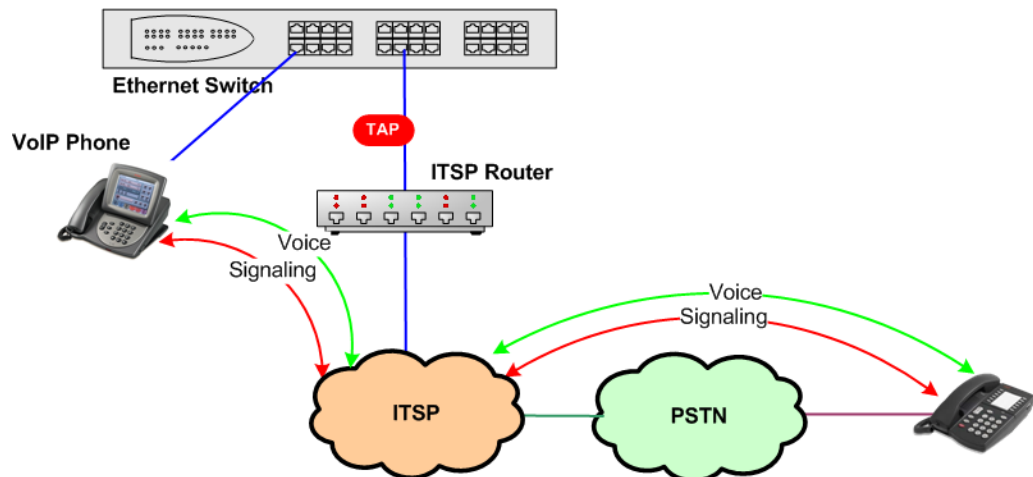

Figure 16: External Call Packet Flow

The VoIP service provider acts a Media Gateway and provides connections to other telephone networks (in particular the PSTN).

6.7.4. Complex VoIP Networks

Complex VoIP networks use separate signalling and media servers. Some actually use multiple signalling and media servers, depending on the geographic locations of the enterprise.

In such networks it is best to tap all end-point links in order to record internal VoIP calls as shown on the following diagram.

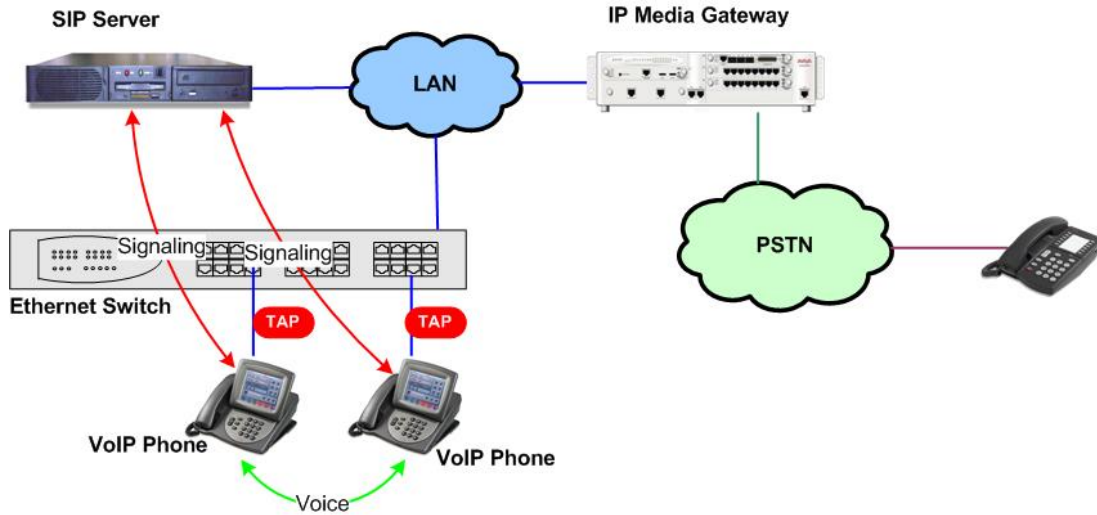

Figure 17: Internal Call Packet Flow

The same strategy works for external calls as shown on the following diagram.

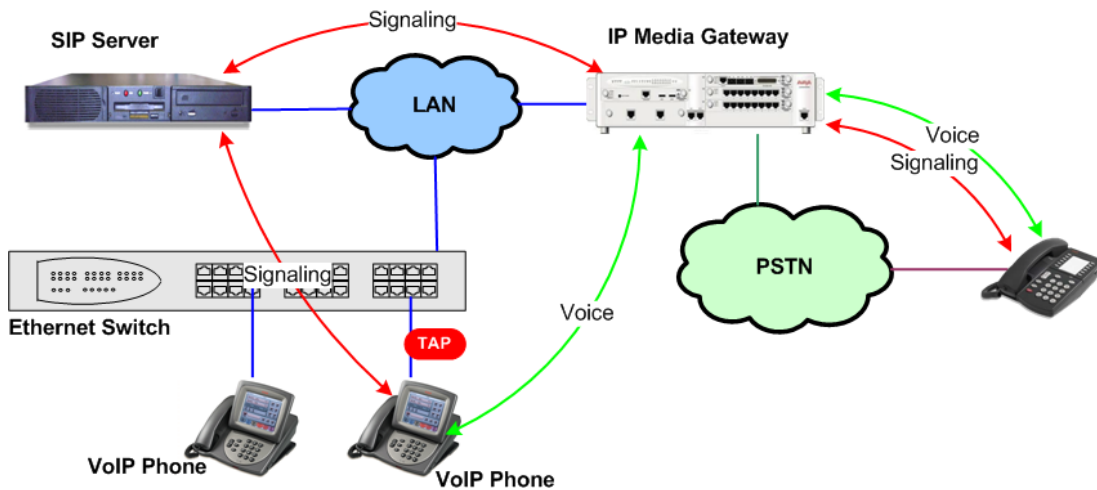

Figure 18: External Call Packet Flow

7. Active VoIP Recording



Active VoIP recording is available only on Total Recall VR systems that are based on LinX technology.

Total Recall VR systems that are based on Max technology DO NOT support active VoIP recording.

7.1. Overview

Total Recall VR uses a built-in SIP Media Server to record SIP sessions in active mode.

Unlike passive VoIP recording, active VoIP recording does not depend on SPAN ports and other Ethernet link tapping devices. Instead, other equipment simply establishes a SIP session with Total Recall VR and then sends the audio to be recorded to Total Recall VR.

This greatly simplifies the deployment of Total Recall VR for the purpose of recording SIP calls on SIP telephony networks. In addition it enables Total Recall VR to integrate with radio consoles, controllers and base stations that use a SIP based interface to recording equipment.

The SIP Media Server does not register with a SIP Registrar and accepts all SIP sessions attempts from equipment on the network. In addition, it is only capable of receiving RTP packets during SIP session. It does not send RTP packets.

7.2. Interface

Total Recall VR uses one of its LAN interfaces to accept SIP sessions for the purpose of recording.

Total Recall VR has two LAN interfaces: LAN 1 and LAN 2. It is recommended to configure the UDP services for SIP and RTP to use the LAN 2 interface. This leaves the LAN 1 interface free to use for all other network communication, for example communication with Remote Manager.

7.3. Supported Protocols

Total Recall VR supports the following protocols and media codecs for active VoIP recording:

- SIP over UDP (RFC3261, RFC2976, RFC2833).
- SDP (RFC3264).
- RTP (RFC 3550).
- Encoding method: G.711 (A or μ -law), 8000Hz, 64Kbps, mono.

7.4. Deployment Rules

The following rules apply when deploying a Total Recall VR on a VoIP network for the purpose of recording in active mode:

1. All end-points, the telephone system and radio equipment must use the G.711 (A or μ -law) codec during calls.
2. Silence suppression must be disabled.
3. If SDP messages do not specify the ‘ptime’ parameter, then each RTP packet must carry exactly 20ms of audio (or 160 audio signal samples).
4. All endpoints, the telephone system and radio equipment must use the same ‘ptime’.
5. SIP encryption must be disabled.
6. RTP encryption must be disabled.

7.5. VoIP Extensions

Section 5.7 Total Recall VR Extensions explained the importance of Total Recall VR Extensions to the operation of Total Recall VR.

Total Recall VR uses calling and called party identifiers as a starting point (or Raw identifiers) in the process of determining Total Recall VR Extensions for calls on VoIP networks.

For SIP networks it uses the values of the “From” and “To” header fields in the 200 response to the INVITE message. For example, Total Recall VR will use “sip:alice@atlanta.example.com” and “sip:bob@biloxi.example.com” as Raw identifiers if it receives the subsequent message:

```

8.      SIP/2.0 200 OK
9.      Via: SIP/2.0/TCP client.atlanta.example.com:5060;branch=z9hG4bK74bf9
10.     From: Alice <sip:alice@atlanta.example.com>;tag=9fxcde76sl
11.     To: Bob <sip:bob@biloxi.example.com>;tag=8321234356
12.     Call-ID: 3848276298220188511@atlanta.example.com
13.     CSeq: 1 INVITE
14.     Contact: <sip:bob@client.biloxi.example.com;transport=tcp>

```

7.6. Deployment Scenarios



The diagrams in this section use green and red lines to show logical flow of VoIP packets, rather than the actual physical route that packets take.

7.6.1. Recording Server

Total Recall VR can work as a recording server on SIP telephony networks and provide call recording service for endpoints on the network.

In this case Total Recall VR must be deployed on the SIP network so that all SIP endpoints (telephones) and SIP servers that need to use the recording service are able to reach Total Recall VR on the network.

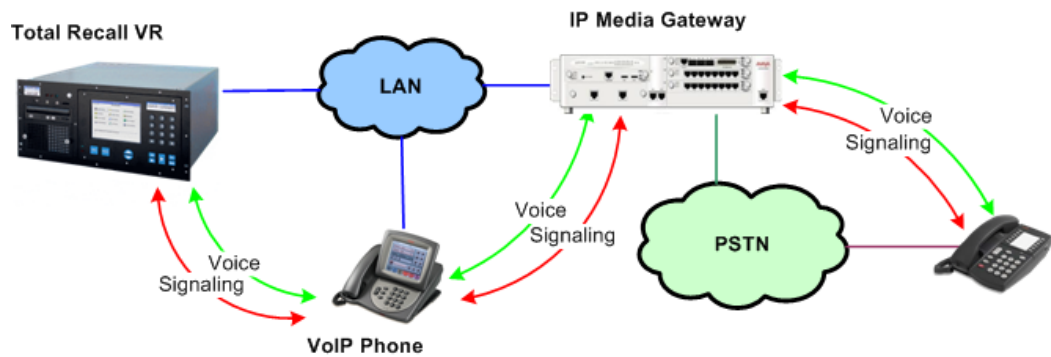

Figure 19: Total Recall VR as SIP Recording Server

To use the recording service, SIP endpoints need to add Total Recall VR to a SIP session in progress. This is easily done by creating a 3-way conference at the SIP endpoint. The 3-way conference connects the calling and called party with Total Recall VR which will record the conversation between the calling and called party for the duration of the 3-way conference.

7.6.2. Radio Recording

Increasing number of radio systems support a SIP based interface to recording equipment. Total Recall VR can integrate with such equipment and record radio conversations.

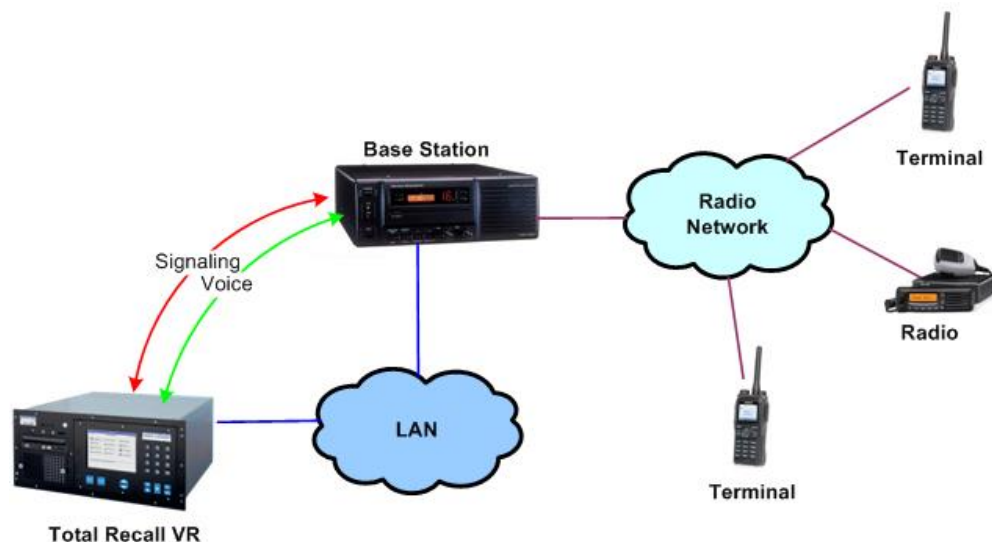

Figure 20: Total Recall VR as Radio Recording Server

To use the recording service radio equipment simply create a SIP session with Total Recall VR and then send the audio that needs to be recorded to Total Recall VR.

8. RoIP (and AoIP) Recording



RoIP and AoIP recording is available only on Total Recall VR systems that are based on LinX technology.

Total Recall VR systems that are based on Max technology DO NOT support RoIP and AoIP recording.

8.1. Overview

Total Recall VR is capable of recording audio that is transported with the standard RTP and proprietary protocols (such as Tait VRP) in passive and active mode. Such protocols are extensively used by RoIP and AoIP system.

8.1.1. Passive Recording Mode

In passive mode Total Recall VR uses a software based RTP packet collector which is capable of detecting, extracting and then processing RTP packets when connected to an Ethernet link.

The packet collector does not interact with the packets on the Ethernet link in any way. It does not add, remove or modify packets. It simply detects and takes a copy of each packet for further processing.

Each Total Recall VR is equipped with a single IP packet collector capable of collecting RTP packets from a single Ethernet link. A separate appliance, Total Recall VR Traffic Collector, enables Total Recall VR to collect packets from up to four Ethernet links.

8.1.2. Active Recording Mode

In active mode Total Recall VR accepts RTP and Tait VRP packets on user configurable UDP ports, also known as UDP services. RoIP equipment can send RTP and VRP packets to the UDP services for the purpose of recording.

This interface receives RTP and VRP packets only. It does not send packets to the network.

It is possible to define two different types of UDP services for recording audio in RTP packets: stream UDP service and stream-pair UDP service. The stream UDP service stores audio from each RTP stream that it receives in a separate recording file. The stream-pair UDP services receive RTP streams on two UDP ports and then mix the audio received in each RTP stream before storing it in a recording file.

8.2. Interface

8.2.1. Passive Recording Interface

Total Recall VR uses one of its two LAN interfaces to collect RTP packets. The configuration of the VoIP packet collector specifies which LAN interface.

Traffic Collector uses up to four of its LAN interfaces to collect RTP packets. It also uses one of the four LAN interfaces to send packets that it collects to one of up to four Total Recall VRs.

Total Recall VR has two LAN interfaces: LAN 1 and LAN 2. It is recommended to configure the packet collector to use the LAN 2 interface. This leaves the LAN 1 interface free to use for all other network communication, for example communication with Remote Manager.

8.2.2. Active Recording Interface

Total Recall VR uses one, or both, of its LAN interfaces to receive RTP and VRP packets. The configuration of the stream and stream-pair UDP services, as well as the VRP service configuration, specify which LAN interface.

Total Recall VR has two LAN interfaces: LAN 1 and LAN 2. It is recommended to configure the UDP services to use the LAN 2 interface. This leaves the LAN 1 interface free to use for all other network communication, for example communication with Remote Manager.

8.3. Supported Protocols

Total Recall VR supports the following protocols and media codecs when recording in a RoIP or AoIP environment:

- RTP (RFC 3550).
- Tait VRP.
- Omnitronics RoIP.
- Hytera RoIP.
- Encoding method:
 - G.711 (A or μ -law), 8000Hz, 64Kbps, mono.
 - AMBE, 8000Hz, 2450bps, mono (Tait VRP only).

8.4. RoIP Extensions

Section 5.7 Total Recall VR Extensions explained the importance of Total Recall VR Extensions to the operation of Total Recall VR.

When recording RTP streams in passive mode, Total Recall VR uses the source IP address and port and the destination IP address and port as Raw identifiers. For example, if an RTP packet has source IP address 192.168.20.2 and UDP port 5000 and destination IP address 192.168.30.9 and UDP port 7000, then Total Recall VR will use 192.168.20.2:5000 and 192.168.30.9:7000 as Raw identifiers.

When recording RTP streams in active mode, Total Recall VR uses the source IP address and port and the UDP service IP address and port as Raw identifiers. For example, if an RTP packet has source IP address 192.168.20.2 and UDP port 5000 and it arrives at UDP service on IP address 192.168.2.100 and UDP port 12000, then Total Recall VR will use 192.168.20.2:5000 and 192.18.2.100:12000 as Raw identifiers.

Similar to RTP streams, when recording RTP stream pairs in active mode, Total Recall VR uses a combination of the source IP address and port and the UDP service IP address and port as Raw identifiers. However, in this case there are two sources of RTP packets and two UDP services so each of the identifiers is a combination such as 192.168.20.2:5000; 192.18.2.100:12000.

Finally, when recording in a Tait VRP environment, Total Recall VR uses MPT 1327 addresses or MPT 1343 numbers as Raw identifiers.

The Raw identifiers then go through the mapping process explained in section 5.7 to determine first Mapped identifiers and then Extensions.

8.5. Packet Capture Methods

8.5.1. Passive Packet Capture

Total Recall VR must be deployed in such a way so that all RTP packets that should be recorded are presented to the LAN interface that is used by the VoIP packet collector.



Total Recall VR uses the VoIP Packet Collector to record VoIP calls and RTP streams.

There are a number of ways to achieve this:

1. Using an Ethernet hub – see section 6.6.1 Ethernet Hub for details.
2. Using an Ethernet link tap – see section 6.6.2 Aggregating Ethernet Tap for details.
3. Using a SPAN (or mirroring) port on an Ethernet switch – see section 6.6.3 SPAN Port for details.

8.5.2. Active Packet Capture

Total Recall VR must be connected to a working IP network when using active packet capture.

In this mode, Total Recall VR starts a one or more UDP services on one or both of its LAN interfaces. Other equipment on the network can then send RTP packets to any of the UDP services on the Total Recall VR over the network for the purpose of recording.

8.6. Deployment Scenarios



The diagrams in this section use green and orange lines to show logical flow of packets, rather than the actual physical route that packets take.

For example, in the subsequent diagram (Figure 19), packets actually pass through the Ethernet switch, even though that is not what is explicitly shown.

8.6.1. Passive RTP Packet Capture

Similar to recording VoIP calls in passive mode, it is important to identify the correct Ethernet link, or links, on a RoIP network to tap in order to successfully deploy Total Recall VR to record RTP streams in passive mode.

Total Recall VR must be deployed in such a way so that all RTP packets that should be recorded are presented to the LAN interface that is used by the VoIP packet collector.

In addition to identifying the correct Ethernet link to tap, it is important to understand the Total Recall VR RTP Endpoint configuration, as Total Recall VR uses it to determine which RTP packets it should collect from Ethernet links that are connected to it.

As far as Total Recall VR is concerned, an RTP Endpoint is defined by its IP address and UDP ports that it uses to send and receive RTP packets on the network. The UDP ports that are used by the RTP Endpoint to send RTP packets are specified as Tx Ports, while the UDP ports used to receive RTP packets are specified as Rx Ports in the RTP Endpoint configuration.

In most cases a SPAN port on an Ethernet switch will be used to present RTP packets to one of the LAN interfaces on a Total Recall VR. This is shown on the subsequent figure.

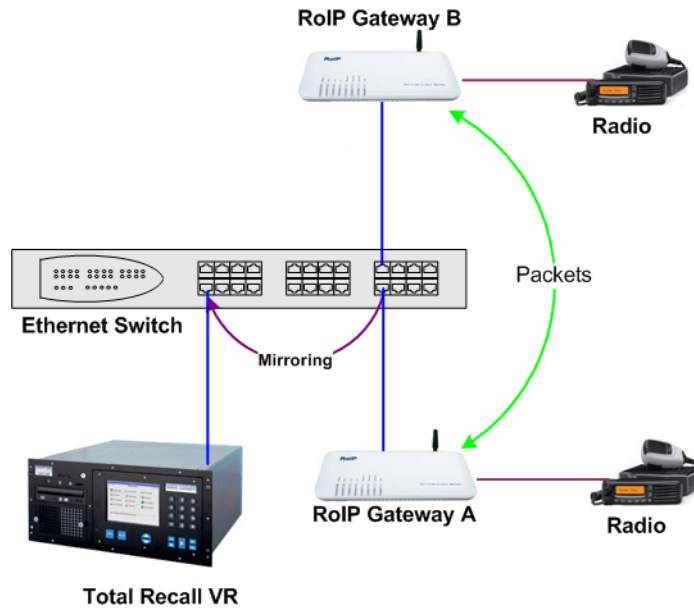

Figure 21: RTP Stream Recording via SPAN Port

In this example the RoIP Gateways are the RTP Endpoints as far as Total Recall VR is concerned. If we assume that the RoIP Gateway A has IP address 192.168.10.10 and is using UDP port 7070 to send RTP packets and UDP port 9090 to receive RTP packets, then the following RTP Endpoint configuration scenarios are possible:

IP Address	Tx Port	Rx Port	Comment
192.168.10.10	7070		Total Recall VR will record all RTP packets that are sent by the RoIP Gateway A.
192.168.10.10		9090	Total Recall VR will record all RTP packets that are received by the RoIP Gateway A.
192.168.10.10	7070	9090	Total Recall VR will record all RTP packets that are sent and received by the RoIP Gateway A, but in separate recording files, one for sent RTP packets and another for received RTP packets.

It is important to note that in this scenario the RoIP Gateways do not send RTP packets directly to the Total Recall VR.

8.6.2. Active RTP Packet Capture

Total Recall VR uses UDP port services to capture RTP packets in active mode. The UDP port services are defined in the RTP Stream and RTP Stream Pair configuration.



Total Recall VR must be configured as a reachable IP endpoint on the network that it is connected to in order to capture RTP packets in active mode.

That is, other systems on the network, such as RoIP Gateways must be able to send RTP packets to Total Recall VR over the IP network.

RTP Streams are basically a single UDP port service that is available on one of the LAN interfaces, usually the LAN 2 interface. Other system on the network can send RTP packets to this UDP service for the purpose of recording as shown on the subsequent figure.

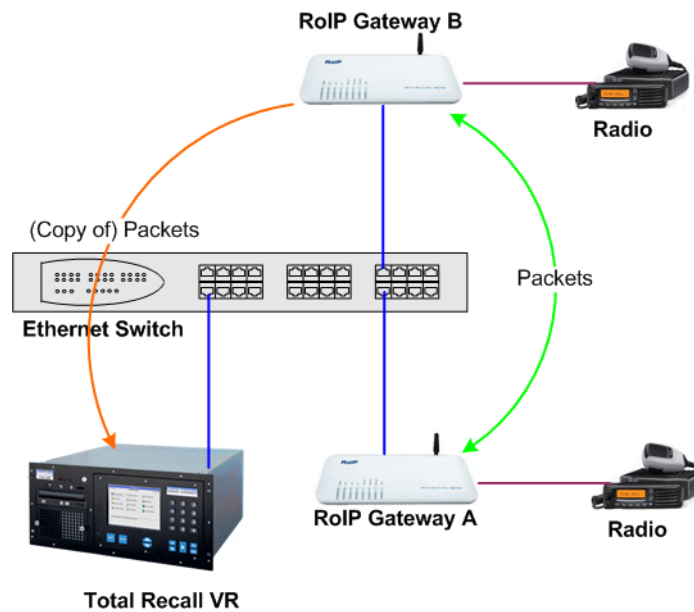

Figure 22: RTP Stream Recording with UDP Port Service

If we assume that the Total Recall VR configuration comprises of a single RTP Stream with IP address 192.168.2.100 and UDP port 9000, then the RoIP Gateway B can send (copies of) RTP packets to UDP service 192.168.2.100:9000 for the purpose of recording.

The previous example assumes that the RoIP Gateway is capable of sending both sent and received RTP packets to single UDP service. Some RoIP Gateways send sent and received RTP packets to two UDP services, one for sent and another for received RTP packets. If this is the case, then configure RTP Stream Pairs on the Total Recall VR.

RTP Stream Pairs are a pair of UDP port service that are available on one of the LAN interfaces, usually the LAN 2 interface. An audio mixer is attached to the pair and

mixes audio received on each of the ports before presenting the audio to the recorder. As a result, a single recording will contain the audio received on both UDP ports. Other system on the network can send RTP packets to the UDP services for the purpose of recording as shown on the subsequent figure.

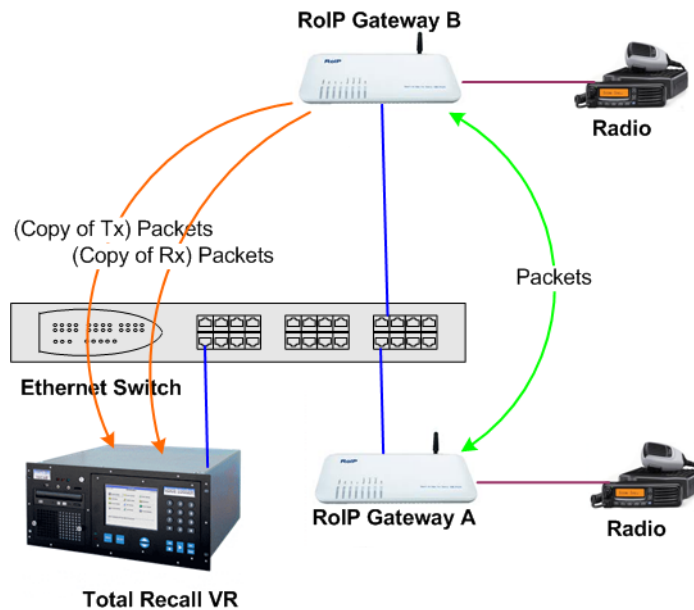

Figure 23: RTP Stream Recording with Dual UDP Port Service

If we assume that the Total Recall VR configuration comprises of a single RTP Stream Pair with IP address 192.168.2.100, Tx UDP port 7000 and Rx UDP port 7002, then the RoIP Gateway B can send (copies of) sent RTP packets to UDP service 192.168.2.100:7000 and copies of received RTP packets to UDP service 192.168.2.100:7002 for the purpose of recording.

8.6.3. Tait VRP Recording

Total Recall VR has full support for the Tait VRP (Voice Recording Protocol) which is used in Tait DMR and MPT-IP solutions.



Total Recall VR must be configured as a reachable IP endpoint on the network that it is connected to in order to communicate with the Tait equipment.

That is, Tait systems on the network must be able to send VRP packets to Total Recall VR over the IP network.

The Tait VRP service is basically a single UDP port (9999 by default) that accepts connections from Tait DMR and MPT-IP systems over a network. Multiple DMR and MPT-IP nodes can send VRP packets to a single Total Recall VR.

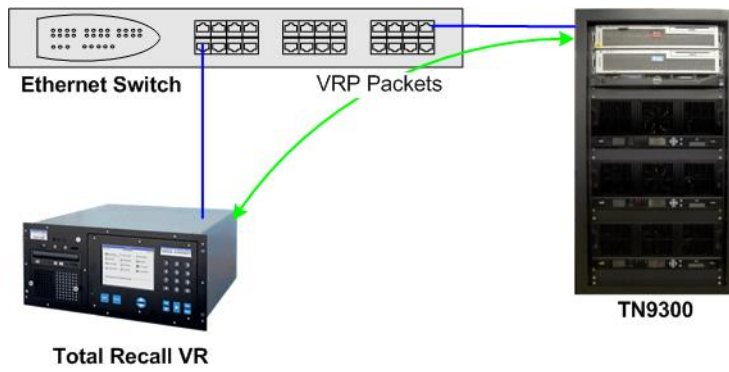

Figure 24: VRP Recording via VRP Service

Total Recall VR supports both the MPT 1343 and MPT 1327 addressing modes, however only one mode (user configurable) at a time.

9. ISDN Call Recording

9.1. Overview

Total Recall VR uses a purpose built high-impedance tapping card to capture signalling and audio on ISDN PRI links.

Different Total Recall VR models support different number of tapping cards as shown on the following table:

Model	Max Cards
Max Rack	4
LinX Evolution	2
LinX Omnia	4

You can connect only one ISDN PRI link to each tap card. As a result, the number of tap cards determines the number of ISDN PRI links that you can connect to Total Recall VR.



DO NOT connect ISDN BRI (2B +D) links to Total Recall VR. Total Recall VR can only record calls on ISDN PRI (E1/T1) links.

Tapping cards do not interact with the signalling and audio on links that they tap in any way. In addition, tap cards do not degrade the signal on links in any way.

9.2. Interface

Tapping cards use two RJ45 (8P8C) connectors to connect to an ISDN PRI link. The connectors are labelled ISDN IN and ISDN OUT.

Pins 1, 2, 4 and 5 of each connector are connected directly to each other. This provides a pass-through connection for the ISDN PRI link when connected to a tapping card. As a result, ISDN PRI links remain fully operational when connected to tap cards even when Total Recall VR is not powered.

The following figure shows the internal connections between the two RJ45 connectors on the tapping card. In addition it shows how to wire the connectors of the cables from the NTU and to the telephone system that will connect to the RJ45 connectors on the tapping card.

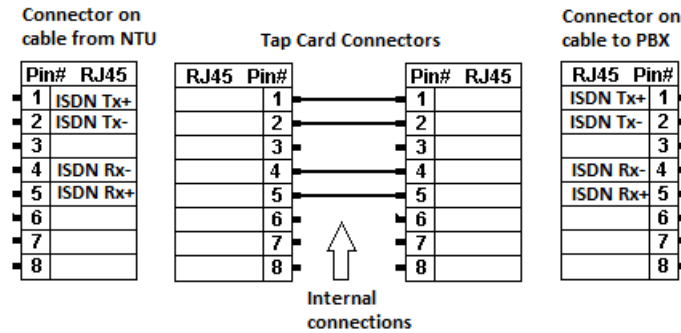

Figure 25: Tapping Card Connector Pin Allocation

To connect an ISDN PRI link to a tapping card on a Total Recall VR:

1. Connect the power cable to the Total Recall VR. This ensures that the earthing protection is in place during the rest of the procedure.
2. Disconnect the ISDN cable from the telephone system by unplugging the cable from the port that it connects to on the telephone system.
 - a. In most cases, and if the Tx pair is connected to pins 1 and 2 and the Rx pair is connected to pins 4 and 5, you can simply connect this cable to a RJ45 connector on the tapping card.
 - b. If the Tx pair is NOT connected to pins 1 and 2 and/or the Rx pair is NOT connected to pins 4 and 5, you must create a custom cable and connect that cable between the NTU and the tapping card.
3. Again, in most cases, and if the Tx pair is connected to pins 1 and 2 and the Rx pair is connected to pins 4 and 5, you can use a straight-through LAN cable, to connect the other RJ45 connector on the same tapping card to the ISDN port of the telephone system.
 - a. However, if the ISDN port on the telephone system uses different pins for the Tx and Rx pair, then you must create a custom cable and connect that cable between the tapping card and the telephone system.

9.3. Supported Protocols

Total Recall VR supports the following protocols and media codecs when recording ISDN telephone calls:

- ITU-T Q.931
- National ISDN 1 and 2, Nortel DMS 100, AT&T 4ESS, Lucent 5ESS, Euro ISDN.
- Encoding method: G.711 (A or μ -law), 8000Hz, 64Kbps, mono.

9.4. ISDN Extensions

Section 5.7 Total Recall VR Extensions explained the importance of Total Recall VR Extensions to the operation of Total Recall VR.

Total Recall VR uses calling and called party identifiers as a starting point (or Raw identifiers) in the process of determining Total Recall VR Extensions for calls on ISDN networks.

Total Recall VR extracts values in the ‘Calling Party Number’ and ‘Called Party Number’ information elements, if present, which appear in the SETUP message. In addition, Total Recall VR can deduce calling identifiers from INFORMATION messages in overlap dialling scenarios.

The Raw identifiers then go through the mapping process explained in section 5.7 to determine first Mapped identifiers and then Extensions.

As ISDN links are almost always trunk side connections (see section 5.4 Trunk Side Recording) it may be necessary to use SMDR integration (see section 5.5 SMDR Integration) to extract telephone system extension numbers during calls and use these to create Total Recall VR Extensions.

9.5. Deployment Scenarios

9.5.1. Trunk Side ISDN Link

In most cases organisation have a single (or multiple) ISDN PRI links on the trunk side of the telephone system. If this is the case, then Total Recall VR simply connects to the ISDN links as shown on the following diagram.

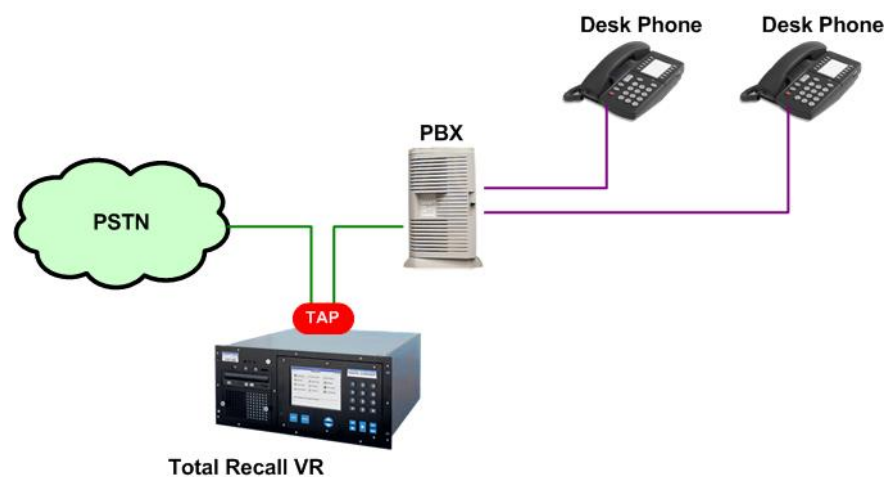

Figure 26: Trunk Side ISDN Link

Note that in this case Total Recall VR will not be able to determine telephone system extension numbers assigned to the desk phones unless:

1. It receives additional information from the telephone system via SMDR integration (see section 5.5 SMDR Integration).

- The organisation has a DID service (see section 5.6 Direct Inward Dial Numbers) and the following Total Recall VR configuration is in place: Signalling Mapping and Internal Dial Plan.

9.5.2. Multi-Site ISDN Links

Many organisations use ISDN links to connect different sites, where they have employees, to a central site, where they house the gateway to the PSTN. If this is the case, then Total Recall VR can connect to all ISDN links as shown on the following diagram.

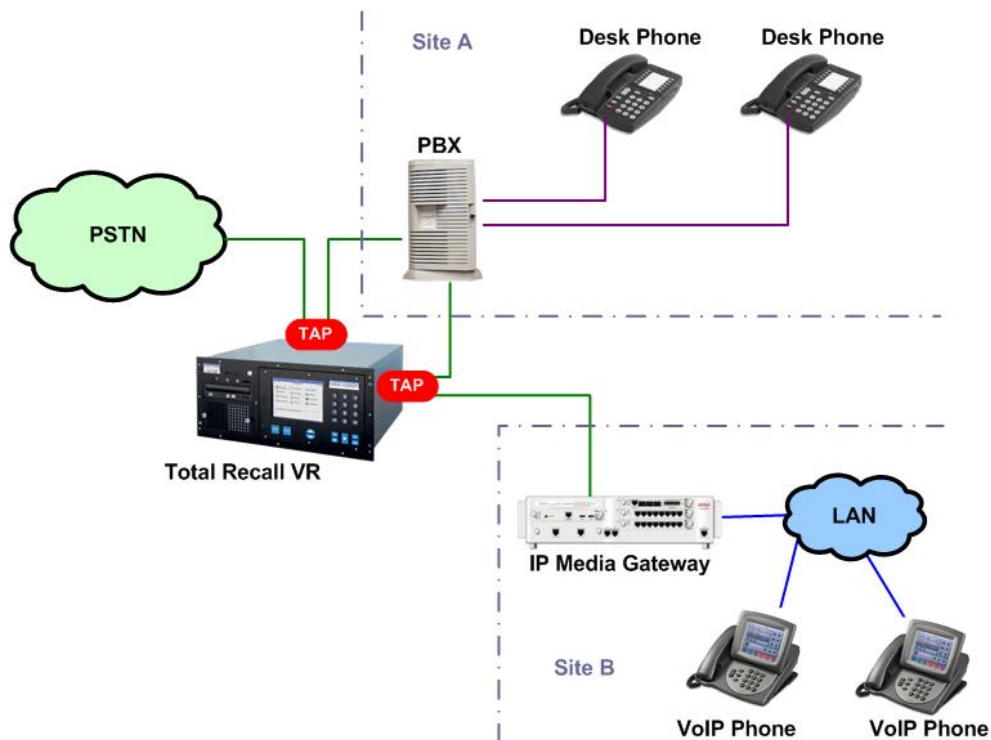

Figure 27: Multi-Site ISDN Links

A single Total Recall VR can capture calls on up to 3 site-to-site ISDN links in addition to the ISDN link to the PSTN, or 4 links in total.

Note that in this case Total Recall VR will not be able to determine telephone system extension numbers assigned to the desk phones for external calls unless:

- It receives additional information from the telephone system via SMDR integration (see section 5.5 SMDR Integration).
- The organisation has a DID service (see section 5.6 Direct Inward Dial Numbers) and the following Total Recall VR configuration is in place: Signalling Mapping and Internal Dial Plan.

9.5.3. ISDN BRI Links

Total Recall VR cannot tap ISDN BRI (2B + D) links directly. It is necessary to use a digital-to-analogue converter (DAC) to convert the ISDN BRI link to two analogue links in order to record calls with Total Recall VR as shown on the following diagram.

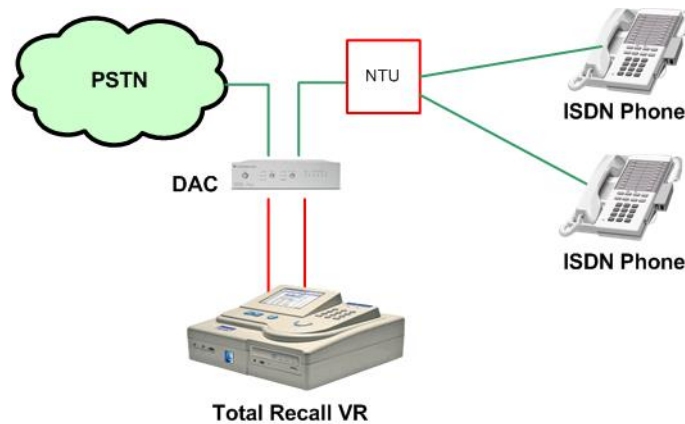

Figure 28: ISDN BRI Links

Note that in this case it is not possible to use SMDR integration (see section 5.5 SMDR Integration) to determine extension information. Instead, use the “Extension” parameter of the analogue recording channel configuration to specify the extensions assigned to each of the ISDN phones.

10. Analogue Source Recording

10.1. Overview

Total Recall VR uses a purpose built analogue channel boards to capture audio from different types of analogue sources and analogue telephone lines.

Analogue channel cards can have 4, 8 or 12 analogue recording channels. Different Total Recall VR models support different number of analogue channel boards as shown on the following table:

Model	Maximum Boards	Maximum Channels
Classic Desktop	2	24
Classic Rack	5	60
Max Rack	5	60
LinX Omnia	5	60
LinX Altus	6	72
LinX Neos	2	24

Each channel can connect to a single analogue source which may be:

1. Analogue telephone line.
2. Output of a digital-to-analogue converter (DAC).
3. Any analogue source with 2-wire output.

Total Recall VR does not interact with the analogue signal on the lines connected to its analogue recording channels in any way, unless its configuration specifies to inject a recording ‘beep’ tone.

10.2. Interface

DSP cards use RJ11C/RJ12/RJ14 (6P6C) connectors. Each connector has two input lines, one line on pins 3 and 4 and another on pins 2 and 5.

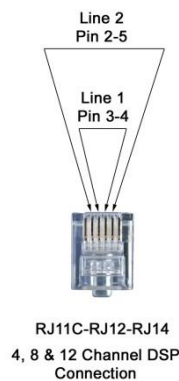

Figure 29: Analogue Recording Channel Wiring

Analogue recording channel numbering starts with the lines on the left-most connector where recording channel 1 and 2 map to line 1 and 2 on the first connector. The numbering then continues in lots of 2 with every adjacent connector.

10.3. Supported Protocols

Total Recall VR supports the following protocols and media codecs when recording telephone calls on analogue telephone lines:

- Caller ID detection: FSKR and DTMF.
- Digit detection: DTMF.
- Encoding method: HQVQ, 8000Hz, 7.9Kbps, mono.

10.4. Analogue Extensions

Section 5.7 Total Recall VR Extensions explained the importance of Total Recall VR Extensions to the operation of Total Recall VR.

Total Recall VR uses calling and called party identifiers as a starting point (or Raw identifiers) in the process of determining Total Recall VR Extensions for calls on analogue networks.

Total Recall VR detects FSKR and DTMF signals which deliver Caller ID to analogue telephones. In addition it detects DTMF digits as dialled on an analogue phone. It uses both as Raw identifiers.

The Raw identifiers then go through the mapping process explained in section 5.7 to determine first Mapped identifiers and finally Extensions.

If FSKR and DTMF signalling is not available on the analogue lines that are connected to analogue recording channels, then Total Recall VR will not be able to determine Raw identifiers for calls, hence it will not be able to establish Total Recall VR Extensions. If this is the case, and if Total Recall VR Extensions are required, then it is mandatory to:

1. Set the “Extension” parameter, which appears in the configuration of every analogue recording channel; and
2. Disable DTMF detection for every analogue recording channel.



Due to differences in international standards for CLI and off-hook, Caller ID captured for an unanswered call is held for five seconds after the last ring.

As a result, if a new call arrives within the five second period, and the new call does not present a Caller ID, then the previous Call ID will be used as a calling Raw identifier for the new call.

10.5. Deployment Scenarios

10.5.1. Analogue Trunk Lines

In most cases organisation have multiple analogue telephone lines on the trunk side of the telephone system. If this is the case, then Total Recall VR simply connects to the analogue telephone lines as shown on the following diagram.

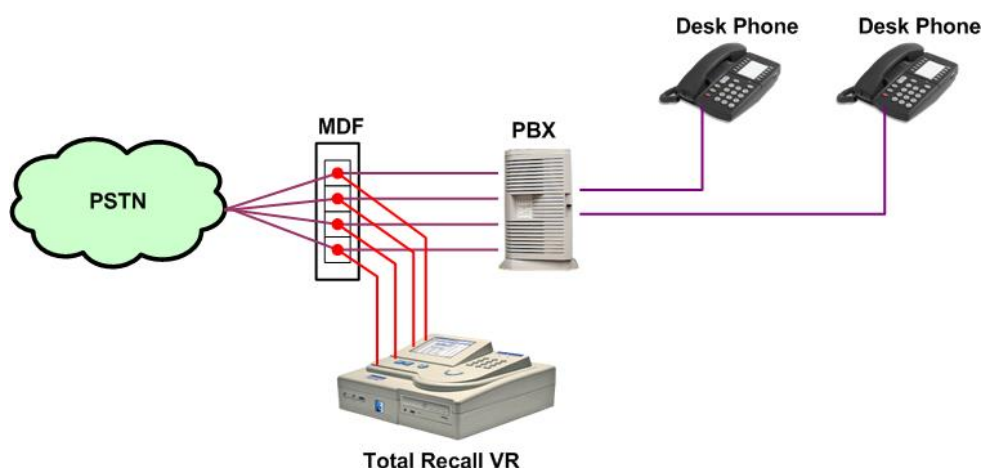

Figure 30: Trunk Side Analogue Telephone Lines

Note that in this case Total Recall VR will not be able to determine telephone system extension numbers assigned to the desk phones unless:

1. It receives additional information from the telephone system via SMDR integration (see section 5.5 SMDR Integration).
2. The organisation has a DID service (see section 5.6 Direct Inward Dial Numbers) and the following Total Recall VR configuration is in place: Signalling Mapping and Internal Dial Plan.

In addition, Total Recall VR will not be able to record any internal calls, or calls between desk phones.

10.5.2. Analogue Extension Lines

Many organisations use analogue telephone devices as their desk phones. If this is the case, then Total Recall VR simply connects to the analogue telephone lines as shown on the following diagram.

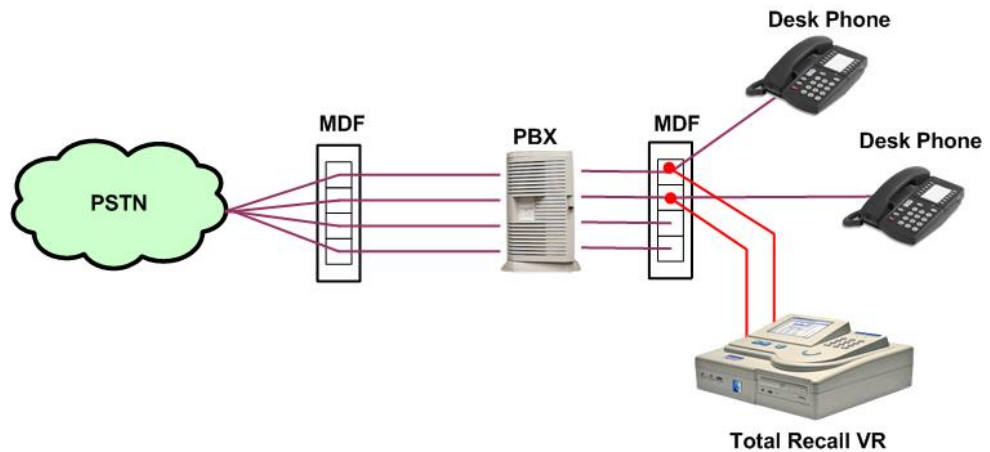

Figure 31: Extension Side Analogue Telephone Lines

Note that in this case Total Recall VR will record all internal calls (calls between the desk phones) as well as all external calls.

SMDR integration (see section 5.5 SMDR Integration) is not needed in this case as Total Recall VR is able to determine extension numbers from the signalling information on the telephone lines.

10.5.3. Digital Desk Telephones

Many organisations use digital desk telephones. Total Recall VR cannot record telephone conversations via direct connections to digital telephone lines. However, it is possible to use the analogue recording channels to record calls after the signal on the digital telephone lines undergoes a digital to analogue (D/A) conversion.



Total Recall VR does not provide D/A conversion. A third party DAC product is required for this function.

The following diagram shows how to connect a digital to analogue converter (DAC) to a digital telephone line so it can be recorded by Total Recall VR.

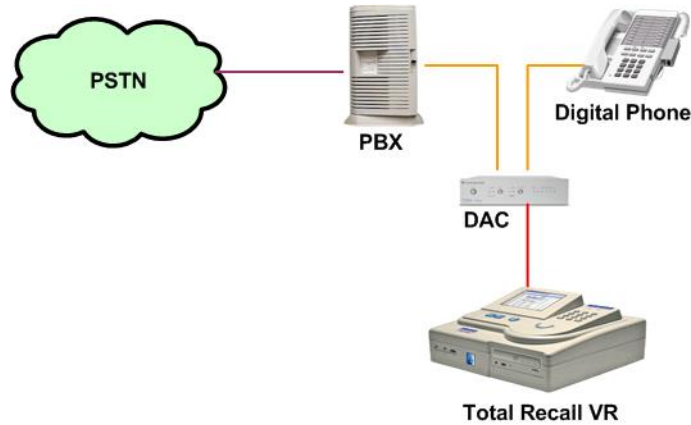

Figure 32: Digital Desk Telephone Recording with DAC

Note that the DACs may connect in series with the telephone line, as shown on the above diagram, or in parallel.

An alternative to DACs are the Total Recall VR Logger Patch accessories. Most digital telephones have analogue audio signal in the headpiece. If this is the case, then a Logger Patch can be used to connect the signal sent to the speaker (earpiece) and received from the microphone (mouthpiece) to a Total Recall VR analogue recording channel.



Figure 33: Digital Desk Telephone Recording with Logger Patch



See section 11 Logger Patch Deployment for details on how to deploy Total Recall VR Logger Patches.

It is sometimes the case that there is a signal level difference between the speaker and microphone, and therefore, in a recorded conversation, one party may be heard more clearly than the other. (This is a limitation of recording via Logger Patches, and not a Total Recall VR recorder limitation).



Total Recall VR is not able to determine Call ID and DTMF information when using Logger Patches because this information is not presented to the handset.

It is mandatory to set the “Extension” parameter and disable DTMF detection in the configuration of every analogue recording channel to enable Total Recall VR to determine Total Recall VR Extensions.

11. Logger Patch Deployment

11.1. Overview

The Total Recall VR Logger Patch enables recording from digital telephone handsets where there is no-side tone or the level of the microphone is too low to trigger recording.



Figure 34: Total Recall VR Logger Patch

The Logger Patch requires a 5VDC to 12VDC power pack to power the amplifier which will give up to 20dB gain on the microphone and 10dB gain on the earpiece. This power pack is NOT supplied with the Logger Patch.



When deciding on a power pack, select power packs with 5VDC to 12VDC 500mA rating and centre positive DC connector with dimensions as shown on the adjacent image.

11.2. Installation

The Logger Patch is simply connected to the telephone handset curly cord and then wired to an analogue port on a Total Recall VR as shown on the subsequent figure.



Figure 35: Digital Desk Phone with Logger Patch

Some phone handsets have different microphone and earpiece outputs to the RJ22 (4P4C) plug. Normally the centre two wires on the handset jack are the earpiece circuit and the outer two wires are the microphone. If your telephone does not use standard connections, there is a splitter included in the pack to reverse the input connections to the Logger Patch.

There are two ways to determine which configuration your handset is:

1. Unplug the handset from the telephone and using a multimeter set to 'ohms' and the ear piece next to your ear, touch the meter probes first on the centre two connectors of the plug. If you hear a click in the earpiece when you make contact the handset is standard. If not, try to probe the outer two contacts. If nothing is heard on either you may not be making contact with the probes.
2. Connect the Logger Patch the standard way. If Total Recall VR only records one side of a call try the non-standard connection.

11.3. Standard Handset Wiring

Handsets with standard wiring use the centre two wires for the earpiece and the outer two wires for the microphone.

To install a Total Recall VR Logger Patch on a desk telephone with standard handset wiring:

1. Unplug the handset cord from your telephone and plug it into the Headset jacks on the Logger Patch.
2. Using the short cable which is supplied with the Logger Patch:
 - a. Plug the end with a RJ22 (4P4C handset) connector into the handset jack on your telephone.
 - b. Then, plug the end with a RJ14 (6P4C) into the Phone jack on the Logger Patch.
3. Your telephone should now function normally as you have simply connected a short extension into the handset cord.
4. Plug an AC adapter into the "Power (12VDC)" jack and AC power.
5. There are two small screwdriver adjustable controls on the Logger Patch. One adjusts the level of microphone audio output (up to 20db gain), and the other adjusts the earpiece audio (up to 10db gain). Adjust clockwise to decrease and anti-clockwise to increase the output level as needed.



Figure 36: Logger Patch Wiring - Standard Headset

11.4. Non-Standard Handset Wiring

Handsets with non-standard wiring use the centre two wires for the microphone and the outer two wires for the earpiece.

To install a Total Recall VR Logger Patch on a desk telephone with a non-standard handset wiring:

1. Unplug the handset cord from your telephone and plug it into the Headset jacks on the Logger Patch.
2. Using the supplied Splitter:
 - a. Plug the short cable from the Splitter into the handset jack on your telephone.
 - b. Plug the handset curly cord into the Headset socket of the Splitter.
3. Using the short cable which is supplied with the Logger Patch:
 - a. Plug the end with a RJ22 (4P4C handset) connector into the Logger socket of the Splitter.
 - b. Plug the end with a RJ14 (6P4C) into the Phone jack on the Logger Patch.
4. Your telephone should now function normally as you have simply connected a short extension into the handset cord.
5. Plug an AC adapter into the "Power (12VDC)" jack and AC power.
6. There are two small screwdriver adjustable controls on the Logger Patch. One adjusts the level of microphone audio output (up to 20db gain), and the other adjusts the earpiece audio (up to 10db gain). Adjust clockwise to decrease and anti-clockwise to increase the output level as needed.



Figure 37: Logger Patch Wiring - Non-Standard Headset

12. Audio Mixer Deployment

12.1. Overview

Total Recall VR Audio Mixer is a low noise 2-channel audio mixer that can combine two audio sources into one.

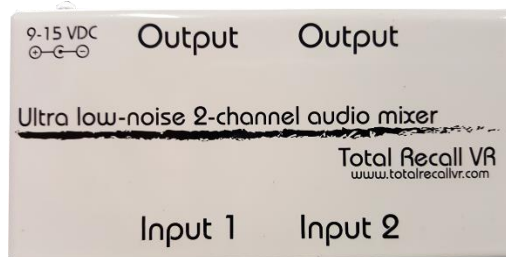

Figure 38: Total Recall VR Audio Mixer

You can use Total Recall VR Audio Mixer to:

- Combine (mix) a stereo audio signals into a mono signal.
- Combine (mix) the transmit (Tx) and receive (Rx) audio signal of a 2-way radio, repeater or base station.
- Combine (mix) any two line level audio signals into a single line level signal.

The Audio Mixer requires a 9VDC to 12VDC power pack to power it. This power pack is NOT supplied with the Audio Mixer.



When deciding on a power pack, select power packs with 9VDC to 12VDC 500mA rating and centre negative DC connector with dimensions as shown on the adjacent image.

12.2. Installation

The Audio Mixer has two inputs and two different types of connectors for each input:

- 3.5mm TS connector; and
- RJ12 connector.

When using the RJ12 connector, connect the signal to pins 3+4 or pins 2+5. Alternatively use the 3.5mm TS connector. However, it is not possible to use both connectors at the same time.

The Audio Mixer has a redundant output; that is, the same mixed signal is available on two independent outputs. As a result, you can connect the same mixed signal to an analogue channel on two recorders if necessary. Similar to the inputs, the Audio Mixer has two different types of connectors for each output:

- 3.5mm TS connector; and
- RJ12 connector.

The output signal is available on pins 3+4 and pins 2+5 on the RJ12 connector. Alternatively you can use the 3.5mm TS connector. However, it is not possible to use both connectors at the same time.

See the following section for examples on how to use the Audio Mixer to combine the TX and Rx audio on some popular brands of 2-way radios and base stations.

13. Radio Mixer Deployment

13.1. Overview

The Total Recall VR Radio Mixer is designed to mix the output from the transmit (Tx) and the receive (Rx) of a 2-way radio base station and produce a two-wire analogue output that is suitable for the Total Recall VR.



Figure 39: Total Recall VR radio Mixer

Most radios have an Accessory Connector at the back of the transceiver. In most cases, the following audio outputs (pins) will be available on the Accessory Connector: Tx Audio, Rx Audio and Audio Ground.

To record both the Tx and Rx communication use a Radio Mixer to combine (mix) the Tx Audio and Rx Audio outputs and then connect the combined output to a Total Recall VR analogue channel.

Common mistake is to connect the DC Ground pins on the Accessory Connector instead of the Audio Ground. In this case the recordings will contain a constant 'hum' or Total Recall VR will not start recording at all.

Other common mistake is to connect the speaker (pins Speaker + and Speaker -) to an analogue channel of a Total Recall VR. This can work, but an impedance mismatch exists (4/8ohm vs 600ohm) which can damage the Total Recall VR analogue channel card as the currents that drive the speaker are much higher (as they need to drive a 4/8 ohm load instead of 600ohm). It is possible to use a transformer to convert from 4/8ohm to 600ohm impedance, but this looks very ugly when deployed and we do not recommend it.

Both the Tx and the Rx inputs of the Radio Mixer have gain control (0 to 26dB) so they can equalise the input levels.

The Radio Mixer requires a 12VDC power pack to power it. This power pack is NOT supplied with the unit.



When deciding on a power pack, select power packs with 12VDC 500mA rating and centre positive DC connector with dimensions as shown on the adjacent image.

13.2. Installation

The Radio Mixer has four connectors:

1. **Recorder:** An RJ12 (6P6C) connector which provides output suitable to connect to an analogue channel of a Total Recall VR.
2. **Power:** DC power supply connector.
3. **Tx Input:** An RJ22 (4P4C handset) connector with signal/ground pins for the Tx output from radios.
4. **Rx Input:** An RJ22 (4P4C handset) connector with signal/ground pins for the Rx output from radios.

The following figure shows the pin assignment for each of the connectors.

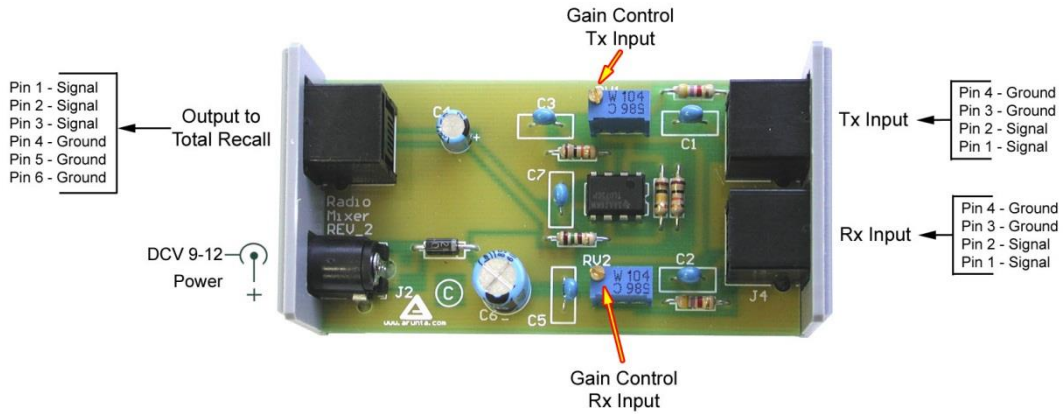

Figure 40: Radio Mixer Connectors and Pin Assignment

To install the Radio Mixer simply connect the Tx and Rx outputs of the radio (accessory connector) to the respective inputs on the Radio Mixer. Then connect the Recorder output of the Radio Mixer to an analogue recording channel on a Total Recall VR.

The following are examples of deploying the Radio Mixer with some radios.

13.2.1. Motorola TETRA MTM800

The Tx and Rx outputs are available from the accessory connector at the back of the transceiver. The following figure, which is reproduced here from the MTM800 installation manual, shows the location of the connector.

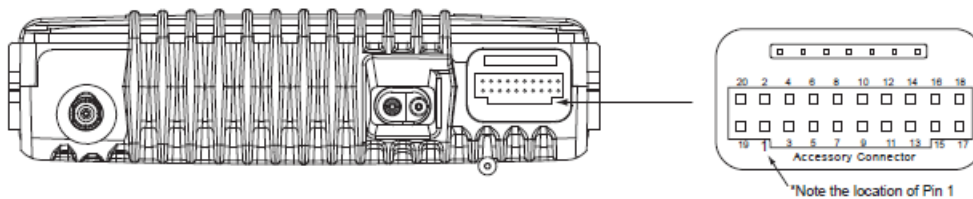

Figure 26 Location of Accessory Connector - Rear Side

Connections:

MTM800	Radio Mixer	
	<i>Tx Input</i>	<i>Rx Input</i>
<i>Accessory Connector</i>		
5	1 or 2	
11		1 or 2
7	3 or 4	3 or 4

13.2.2. Motorola PMR GM3xx

The Tx and Rx outputs are available from the accessory connector at the back of the transceiver. The following figure, which is reproduced here from the GM360 installation manual, shows the location of the connector.

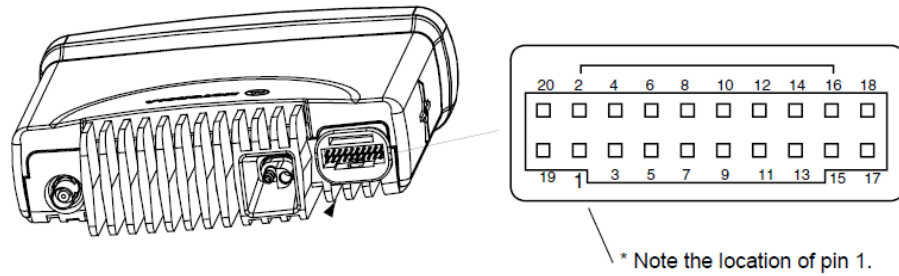

Connections:

GM3xx	Radio Mixer	
	<i>Tx Input</i>	<i>Rx Input</i>
<i>Accessory Connector</i>		
5	1 or 2	
11		1 or 2
7	3 or 4	3 or 4

13.2.3. Motorola DMR DM3xxx

The Tx and Rx outputs are available from the rear connector of the mobile radio unit.

Connections:

DM3xxx	Radio Mixer	
	<i>Tx Input</i>	<i>Rx Input</i>
<i>Rear Connector</i>		
11	1 or 2	
14		1 or 2
12	3 or 4	
16		3 or 4

14. Remote Manager Interface Application Deployment

14.1. Overview

Total Recall VR provides a Java RMI based interface (a.k.a. Remote Manager Interface) that allows client applications, such as Total Recall VR Remote Manager, RoD Client and Supervisor Client, to manage and control it.

This interface depends on a TCP/IP network to connect clients and Total Recall VR systems. The network can be either an enterprise LAN or a dialup link.

In most cases the network will be an enterprise LAN.



Avoid using the dialup links. This feature is will be removed in near future.

14.2. Application Deployment

Due to the virtually infinite number of possible network configurations it is impossible to document installation solutions for all eventualities. However, the examples below should provide an idea of the principles behind deploying Total Recall VR and applications that use the Remote Manager Interface.

14.2.1. Static IP Addressing

In this example the application connects to a Total Recall VR using a static IP address that is assigned to one of the LAN interfaces of the Total Recall VR.

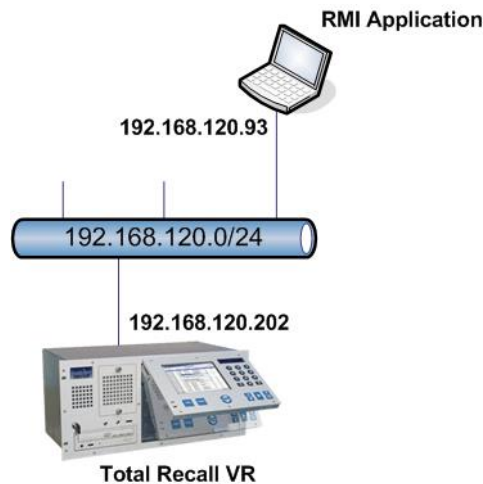

Figure 41: RMI Application using Static IP Address

Configure Total Recall VR Remote Manager Interface to accept client connection on one of its IP addresses (for example 192.168.120.202, port 10010). Then, use the

same IP address and port in the client application when connecting to Total Recall VR.

14.2.2. Hostname Addressing

In this example the application uses a hostname to connect to Total Recall VR. Obviously a working DNS must be available to the application.

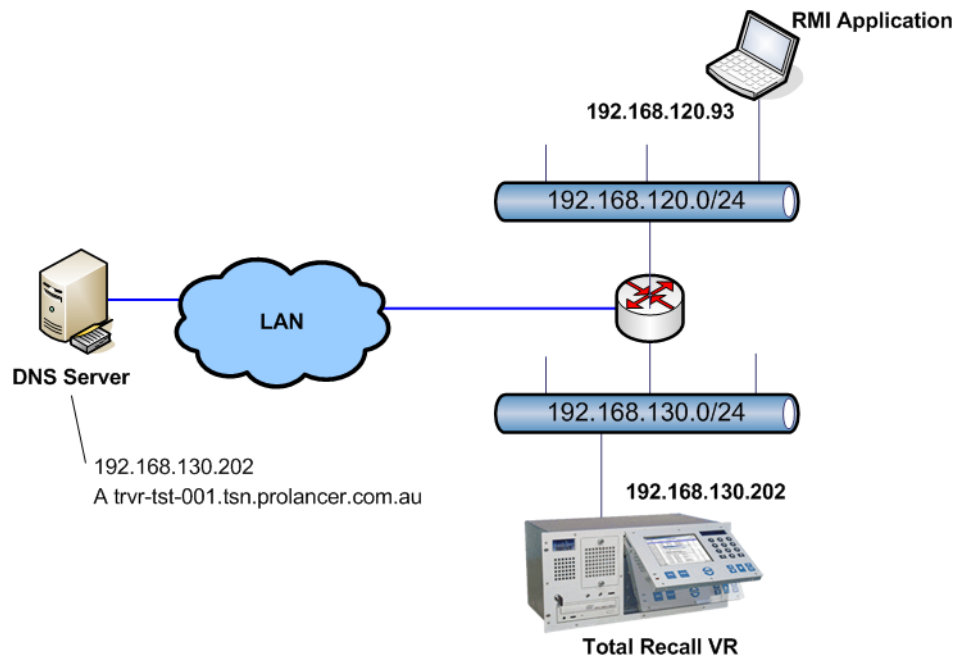

Figure 42: RMI Application using Hostname

The necessary configuration for this example is:

1. Create an 'A' record in DNS that maps a hostname of your choice to an IP address that you plan to assign to Total Recall VR.
For example, create the following DNS entry:
192.168.130.202 A trvr-tst-001.tsn.prolancer.com.au.
2. Assign the IP address from step 1 to one of the LAN interfaces of Total Recall VR (192.168.130.202 from the example).
3. Configure the Total Recall VR Remote Manager Interface to accept client connection on the IP address (192.168.130.202) as well as the hostname (trvr-tst-011.tsn.prolancer.com.au) from step 1. In both cases the base port number (10010) will be the same.

Note that the hostname used by the Remote Manager Interface can be different to the hostname assigned to Total Recall VR as a system on the network. However, the hostname must map to an IP address that is assigned to one of the LAN interfaces of Total Recall VR.

- Configure the application to use the hostname (trvr-tst-011.tsn.prolancer.com.au) from step 1 and base port (10010) from step 3 to connect to Total Recall VR.

14.2.3. Firewall Traversal

In this example the application uses a hostname to connect to Total Recall VR through a firewall. Unlike previous examples, applications cannot use static IP addresses to connect to Total Recall VR through firewalls.

The configuration is slightly different when using the free-to-use PC applications (Remote Manager for example) and the premium PC applications.

Free-to-use PC Applications

The following deployment scenario is an example that will work with the free-to use applications such as the Total Recall VR Remote Manager.

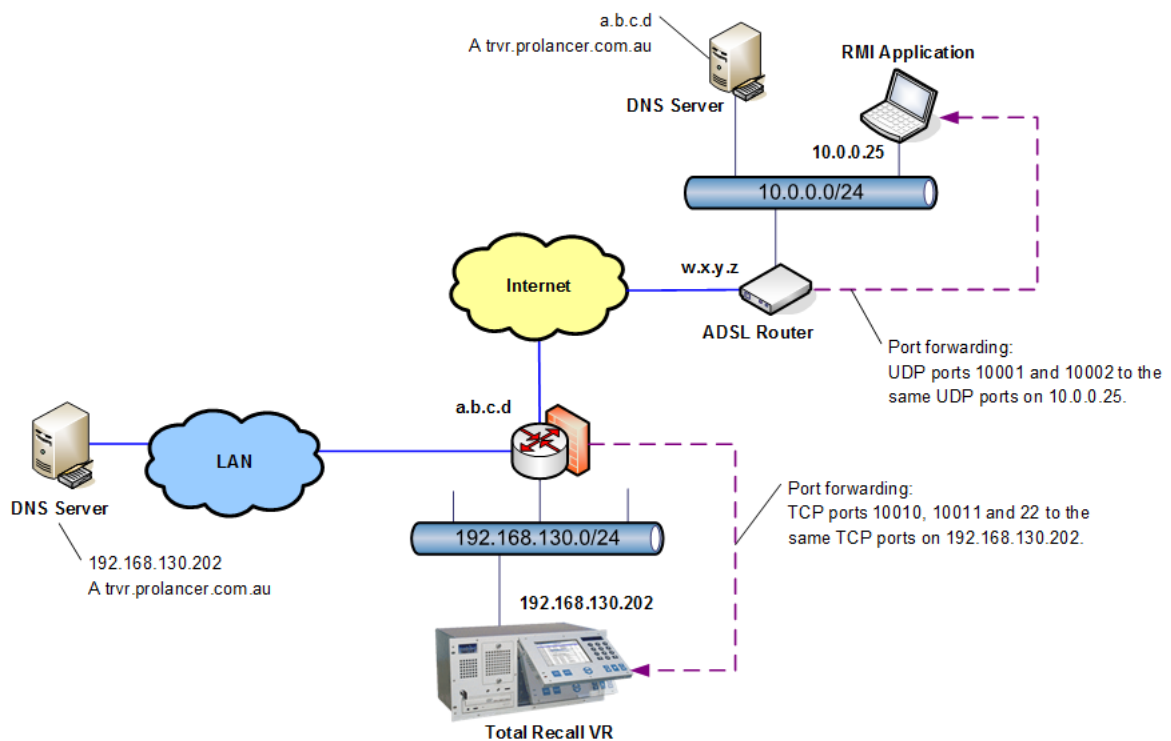

Figure 43: RMI Application through Firewall

This scenario depends on configuration of two name (DNS) servers: one used by Total Recall VR and another by the application. It is very unlikely that both will use the same DNS. However, the DNS used by the application can be eliminated by static configuration in the `hosts` file on the machine that runs the application.

The necessary configuration for this example is:

1. Create an 'A' record in the DNS used by Total Recall VR that maps a hostname of your choice to an IP address that you plan to assign to Total Recall VR.

For example, create the following DNS entry:

```
192.168.130.202 A trvr.prolancer.com.au.
```

2. Assign the IP address used from step 1 to one of the LAN interfaces of Total Recall VR (192.168.130.202 from the example).
3. Configure the Total Recall VR Remote Manager Interface to accept client connection on the IP address (192.168.130.202) as well as the hostname (trvr.prolancer.com.au) from step 1. In both cases the base port (10010) will be the same.

Note that the hostname used by the Remote Manager Interface can be different to the hostname assigned to Total Recall VR as a system on the network. However, the hostname must map to an IP address that is assigned to one of the LAN interfaces of Total Recall VR.

4. Configure the following port forwarding on the Internet router:
 - a. External TCP ports 10010 and 10011 to the same TCP ports on the IP address assigned to Total Recall VR during step 2.

This assumes that the Total Recall VR Remote Manager Interface configuration uses the default base port 10010. If you change the base port during step 3, then you must change the port forwarding rules accordingly. Always create port forwarding configuration for base port and base port + 1.

- b. Optionally, external TCP port 22 to the same TCP ports on the IP address assigned to Total Recall VR during step 2.

This allows for transfer of files from/to Total Recall VR using SCP (secure copy protocol). Note that this is the standard SSH port as well.

5. Create an 'A' record in the DNS used by the application that maps the SAME hostname used during step 1 to the public IP address (a.b.c.d) of the Internet router.

For example, create the following DNS entry (replace a.b.c.d with an actual IP address):

```
a.b.c.d A trvr.prolancer.com.au.
```

6. Configure the application to use the hostname (trvr.prolancer.com.au) from step 5 and base port from step 3 (10010) to connect to Total Recall VR.
7. Configure the following port forwarding on the ADSL router:
 - a. External UDP ports 10001 and 10002 to the same UDP ports on the IP address assigned to PC that is running the RMI application.

It is important to note that the same hostname (trvr.prolancer.com.au in the example) maps to different IP addresses in the two DNS. This is crucial for the correct operation of the connection between the client and Total Recall VR.

The following screen capture shows an example configuration of a connection to a recorder in the Remote Manager application.

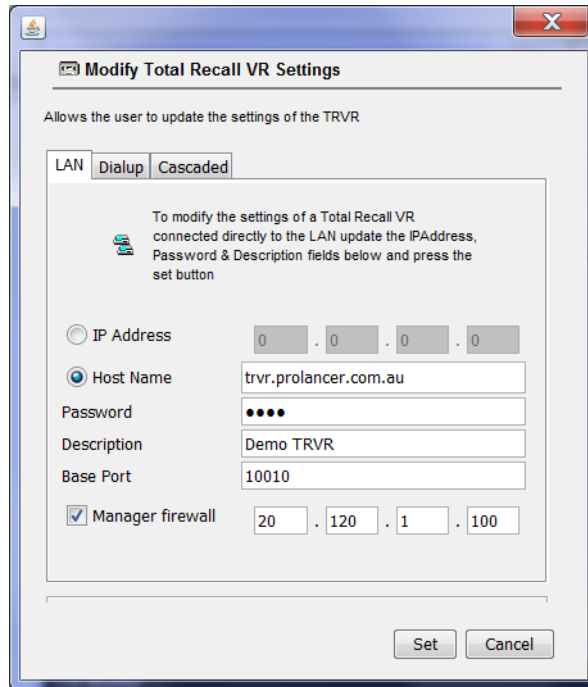

Figure 44: Example Recorder Connection Configuration

The screen capture was taken on a PC which uses a router to connect to Internet and this router has uses IP address 20.120.1.100 as its public IP address (w.x.y.z).

Premium PC Applications

The following deployment scenario is an example that will work with the premium PC applications such as the Total Recall VR Desktop.

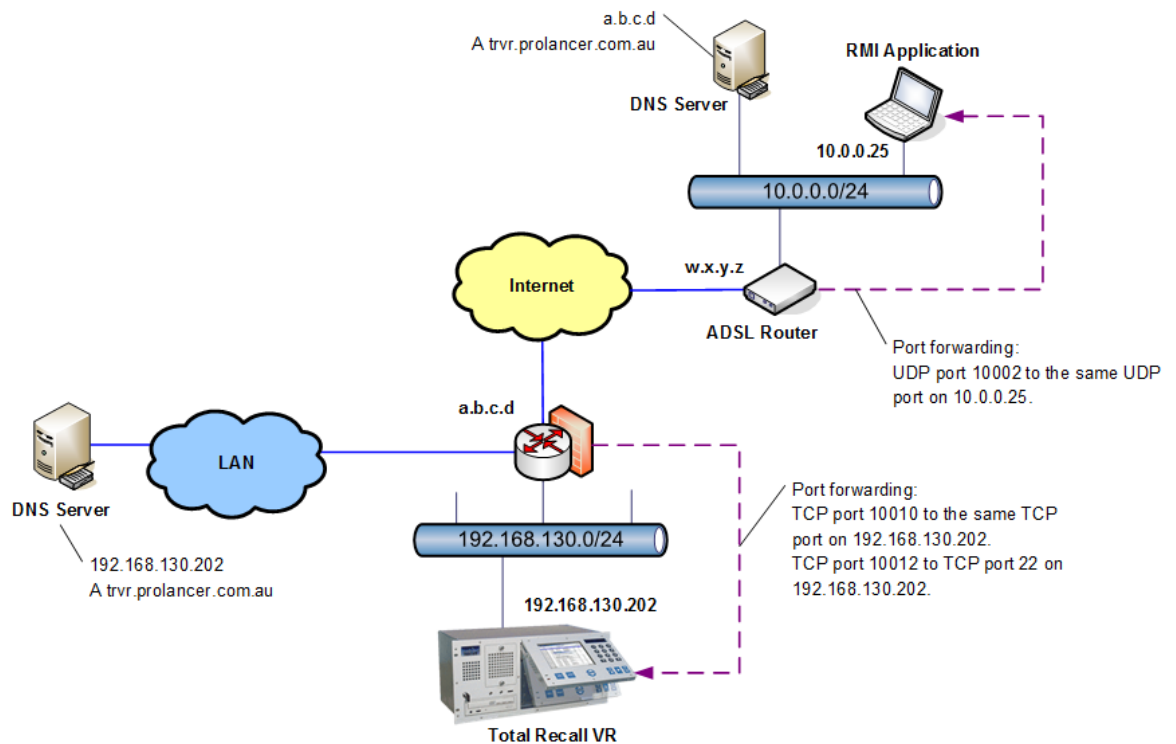

Figure 45: RMI Application through Firewall

This scenario depends on configuration of two name (DNS) servers: one used by Total Recall VR and another by the application. It is very unlikely that both will use the same DNS. However, the DNS used by the application can be eliminated by static configuration in the *'hosts'* file on the machine that runs the application.

The necessary configuration for this example is:

1. Create an 'A' record in the DNS used by Total Recall VR that maps a hostname of your choice to an IP address that you plan to assign to Total Recall VR.
For example, create the following DNS entry:
192.168.130.202 A trvr.prolancer.com.au.
2. Assign the IP address used from step 1 to one of the LAN interfaces of Total Recall VR (192.168.130.202 from the example).
3. Configure the Total Recall VR Remote Manager Interface to accept client connection on the IP address (192.168.130.202) as well as the hostname (trvr.prolancer.com.au) from step 1. In both cases the base port (10010) will be the same.

Note that the hostname used by the Remote Manager Interface can be different to the hostname assigned to Total Recall VR as a system on the network. However, the hostname must map to an IP address that is assigned to one of the LAN interfaces of Total Recall VR.

4. Configure the following port forwarding on the Internet router:

- a. External TCP port 10010 to the same TCP port on the IP address assigned to Total Recall VR during step 2.

This assumes that the Total Recall VR Remote Manager Interface configuration uses the default base port 10010. If you change the base port during step 3, then you must change the port forwarding rules accordingly.

- b. External TCP port 10012 to TCP port 22 on the IP address assigned to Total Recall VR during step 2.

This allows for transfer of files from/to Total Recall VR using SCP (secure copy protocol).

This assumes that the Total Recall VR Remote Manager Interface configuration uses the default base port 10010. If you change the base port during step 3, then you must change the port forwarding rules accordingly. Always create port forwarding configuration for base port + 2.

5. Create an 'A' record in the DNS used by the application that maps the SAME hostname used during step 1 to the public IP address (a.b.c.d) of the Internet router.

For example, create the following DNS entry (replace a.b.c.d with an actual IP address):

```
a.b.c.d A trvr.prolancer.com.au.
```

6. Configure the application to use the hostname (trvr.prolancer.com.au) from step 5 and base port from step 3 (10010) to connect to Total Recall VR.
7. Configure the application to use streaming port 10002.
8. Configure the following port forwarding on the ADSL router:
 - a. External UDP port 10002 to the same UDP port on the IP address assigned to PC that is running the RMI application.

It is important to note that the same hostname (trvr.prolancer.com.au in the example) maps to different IP addresses in the two DNS. This is crucial for the correct operation of the connection between the client and Total Recall VR.

The following screen capture show example streaming configuration of a PC application.

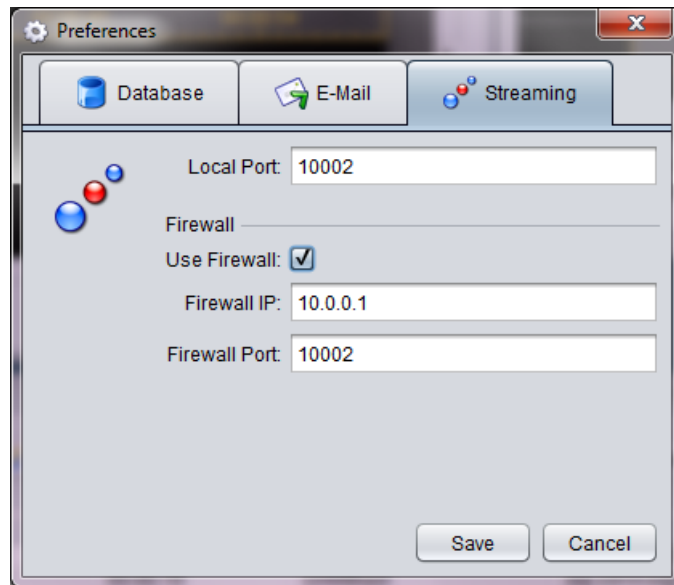

Figure 46: Example Streaming Configuration

The screen capture was taken on a PC which uses a router to connect to Internet and this router has uses IP address 10.0.0.1 as its public IP address (w.x.y.z). The port exposed on the router is 10002 and it configured to port forward to the same port number on the PC that runs the application.

The following screen capture shows an example configuration of a connection to a recorder on the same PC.

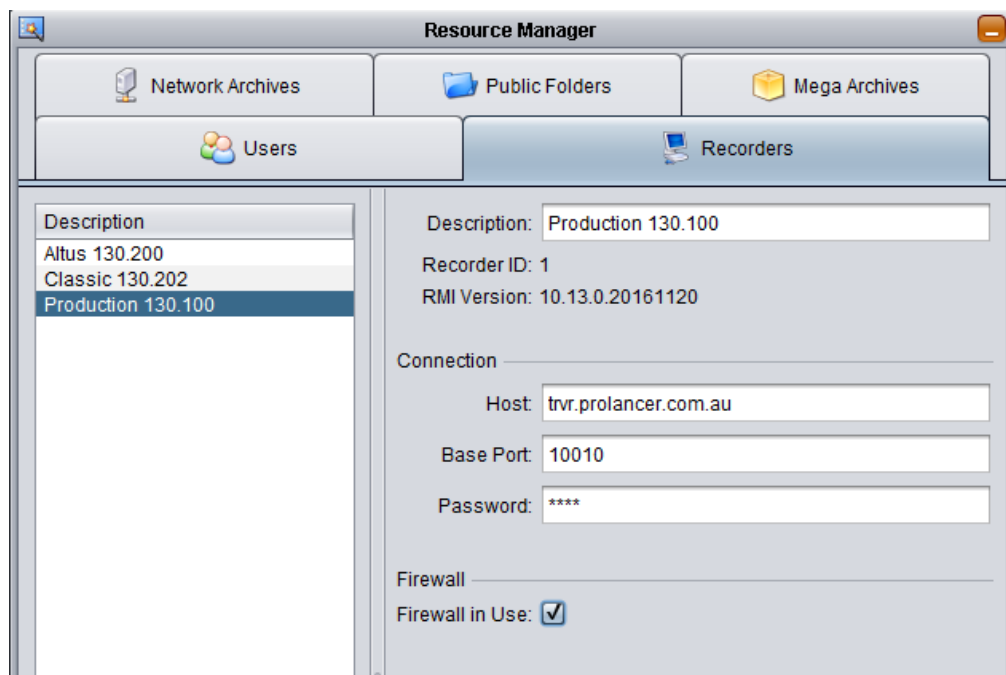

Figure 47: Example Recorder Connection Configuration

15. Application Notes

The following application notes aim to explain, at high level, how to integrate Total Recall VR with equipment from other manufacturers.

15.1. Zetron DCS-5020

15.1.1. Overview

The DCS-5020 radio operator console is very popular with radio operators with smaller operations control rooms. It can control telephone lines as well as both digital and analogue radios from up to 16 operator consoles.

The following diagram shows a typical DCS-5020 solution:

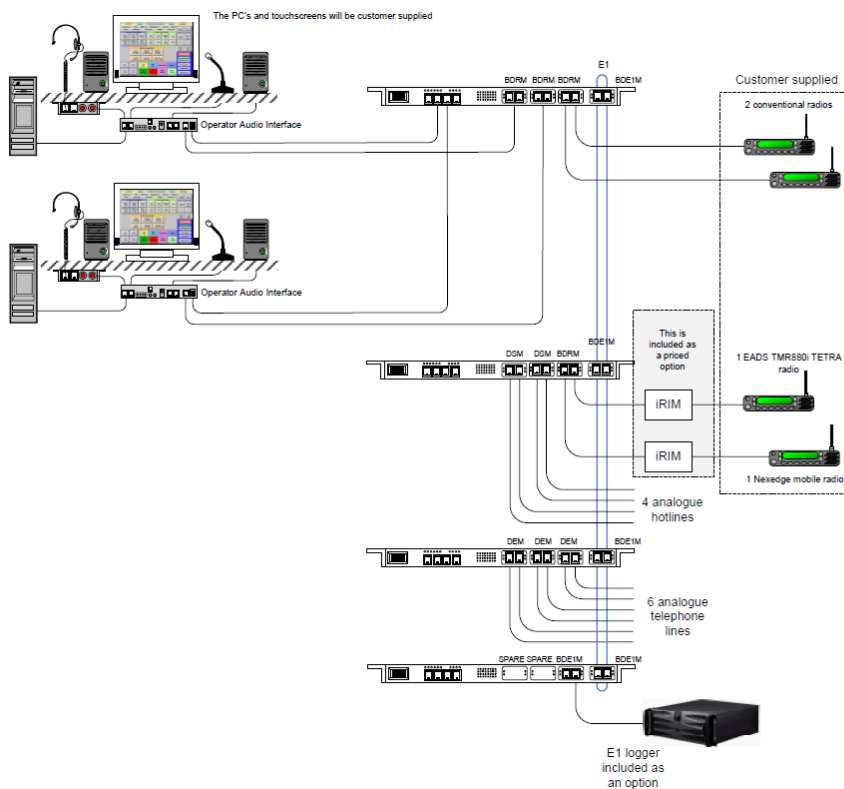

Figure 48: Typical Zetron DCS-5020 Solution

Zetron DCS-5020 manuals explain that recording can be achieved by connecting a recorder with E1 interface to a DE1M module (see bottom of previous diagram). However, the manuals also show this note on recording via a DE1M module:

Voice Logging Note

E1 logging allows flexible assignment of any radio, telephone or console audio port to any of the thirty E1 time slots, and permits summing of transmit and receive audio associated with that port. E1 voice logging does not necessarily accurately reflect the exact audio present at a port – it does not include any locally generated selcall signaling, nor does it reproduce relative volume levels. For voice logging that accurately reflects the exact audio, use the analog recorder outputs of the BDRM and DCOAM modules.



Total Recall VR does NOT support recording via an E1 connection to a DE1M module as this does not accurately reflect exact audio. Instead, it is easy to connect Total Recall VR directly to BDRM, DEM and DSM modules.

15.1.2. Basic Dual Radio Module (BDRM) Recording

The BDRM provides the summed receive and transmit audio for each of the two channels on pins 4 and 5 of the LOCAL connector for the channel. The audio is available on pins 4 and 5 of the LOCAL connector regardless of whether the LOCAL or the RMT jack is used as interface to the radio.

Connect a Total Recall VR analogue channel to pins 4 and 5 of a LOCAL port to capture audio from a radio channel on the BDRM module.

15.1.3. Dual Telephone Set Module (DSM) Recording

This interface allows connection of telephones (or equipment that appear as telephone). It is a standard two wire telephone interface basically.

Connect a Total Recall VR analogue channel in parallel with the telephone capture audio from a channel on the DSM module.

15.1.4. Dual Telephone Exchange Module (DEM) Recording

This interface allows connection of standard analogue telephone subscriber (trunk) lines. It is a standard two wire telephone interface basically.

Connect a Total Recall VR analogue channel in parallel with the trunk line to capture audio from a channel on the DEM module.

15.2. Omnitronics DX-Altus

15.2.1. Overview

The DX-Altus digital radio dispatch system is common with emergency services operators around the world. It is built on top of the Omnitronics' IPR (IP Radio) technology and can work with different radio technologies including DMR, P25, Tetra, PMR and SIP.

The following diagram shows a typical DX-Altus solution:

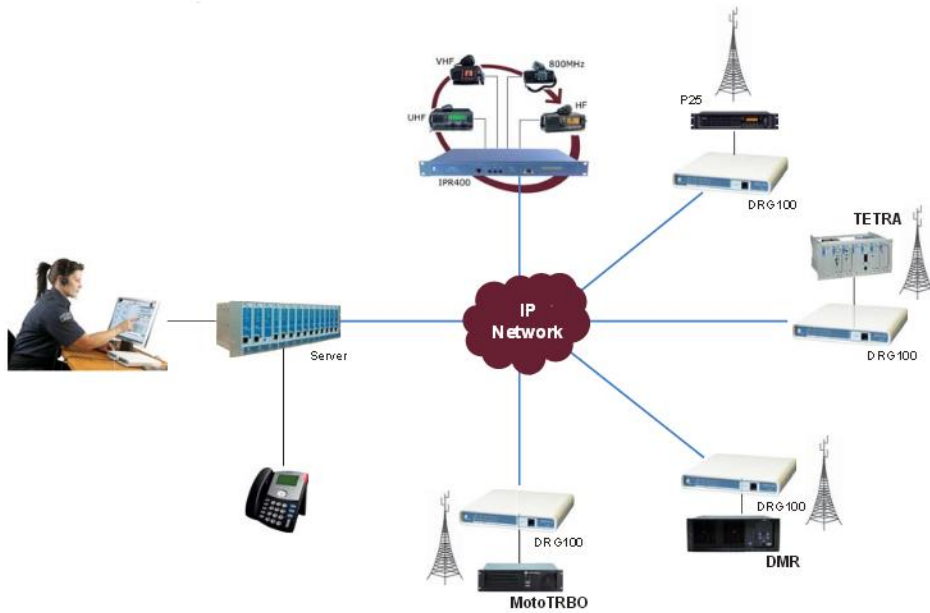

Figure 49: Typical DX-Altus Solution

Total Recall VR supports recording of conversations in a DX-Altus system with analogue and VoIP recording channels as shown on the following figure:

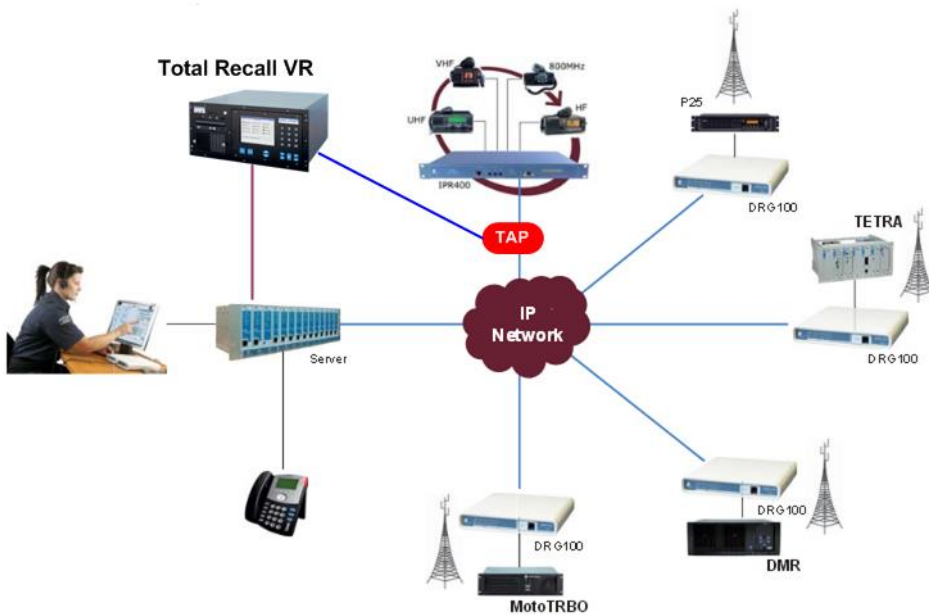

Figure 50: Total Recall VR working with DX-Altus

15.2.2. TMU Recording

The DX-Altux server can be equipped with a number of modules including a Tape Monitoring Interface (TMU) with up to 8 analogue outputs.

Connect Total Recall VR analogue channels to TMU outputs to record radio conversations. Set the analogue recording channels to VoX recording trigger.

15.2.3. IPR Recording

A DX-Altux system can use a number of IPR-100 or IPR-400 RoIP gateways.

Total Recall VR VoIP recording channels support recording of RTP streams between IPR units. To record such streams configure an RTP Endpoint in Total Recall VR using the IP address and port used by an IPR gateway. In addition, configure the following payload types for the RTP Endpoint:

Event Payload Type: unset

Named Payload Type: 97

Tone Payload Type: 98

15.3. Tait TN9300

15.3.1. Overview

The Tait TN9300 is at the heart of the Tait DMR Tier 3 trunked solution designed to provide mission critical communication over wide geographic areas.

The following diagram shows a typical solution:

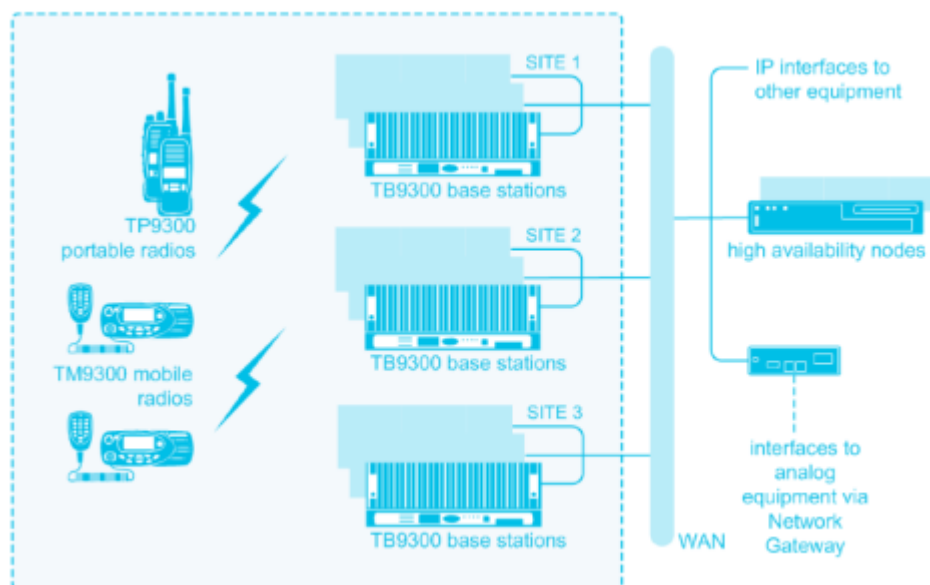

Figure 51: Typical Tait DMR Tier 3 Solution

15.3.2. VRP Recording

Total Recall VR is capable of recording all conversations in a Tait DMR network based on the TN9300 via the Tait VRP protocol.

The VRP protocol is based on RTP and allows Total Recall VR and TN9300 to communicate over an IP network. The following figure shows a Tait DMR Tier 3 solution which is using Total Recall VR:

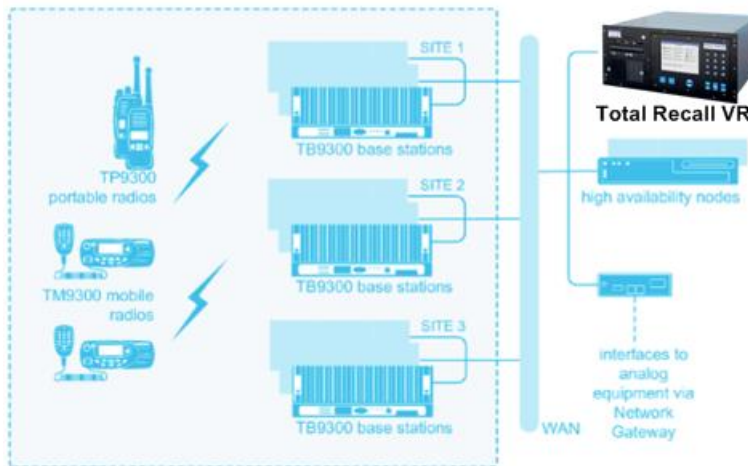

Figure 52: Tait DMR Tier 3 Solution with Total Recall VR

Apart from network connectivity, the solution requires minimal configuration at the Total Recall VR and TN9300 nodes as shown on the following screen captures:

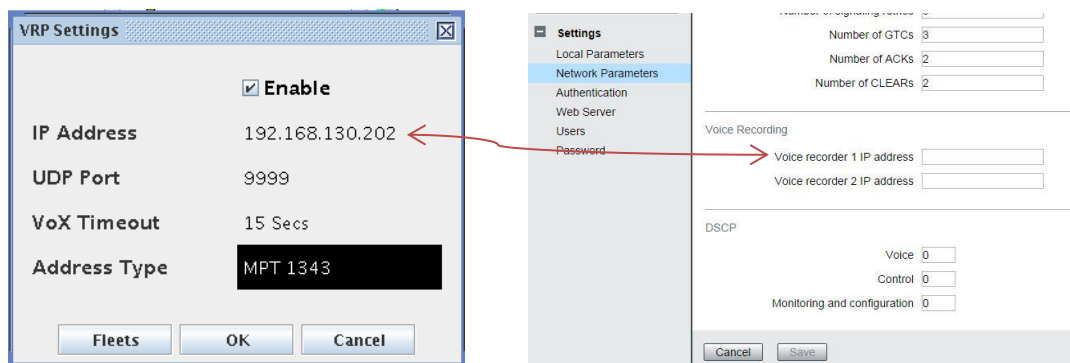

Figure 53: Total Recall VR and TN9300 Configuration

Simply enter the VRP service ‘IP Address’ that is used by Total Recall VR as the ‘Voice recorder 1 IP address’ in the TN9300 configuration. TN9300 uses UDP port 9999 by default.

Note that the TN9300 configuration allows for redundant recorder configuration, the ‘Voice recorder 2 IP address’ parameter. As a result, it is possible to deploy a

redundant pair of Total Recall VRs which can be collocated or geographically distributed for site redundancy.

15.4. Hytera DMR

15.4.1. Overview

Hytera repeaters use the suite of Hytera DMP Application Protocols (HDAP) to interface with applications for the purpose of control and monitoring.

HDAP applications can connect to a Hytera network either to a master repeater or to each repeater as shown on the following diagrams:

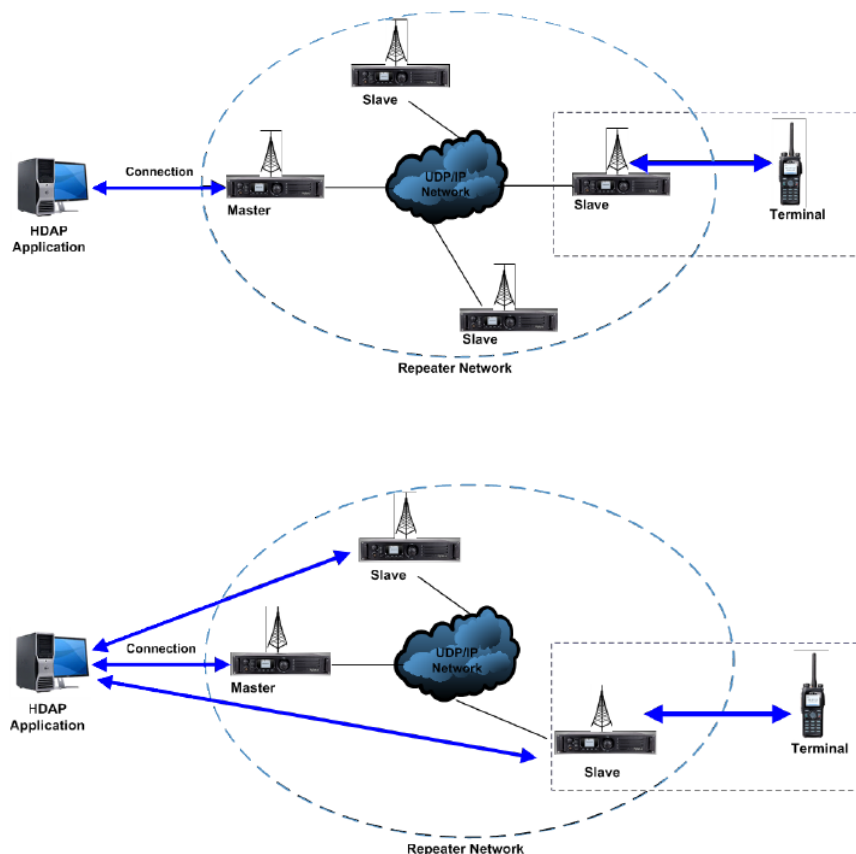

Figure 54: Example Connection to Hytera Network

The connection is over an IP network as all HDAP protocols are IP based.

15.4.2. Hytera RTP Recording

Total Recall VR is capable of connecting to either a Hytera master repeater, or individual repeaters, and receiving RTP packets that contain the Hytera RTP extension for the purpose of recording of the audio that is present in the RTP packets.

To records RTP streams sent by Hytera repeaters you must define a pair of RTP Streams for each repeater in the Total Recall VR configuration as shown on the following screen capture:

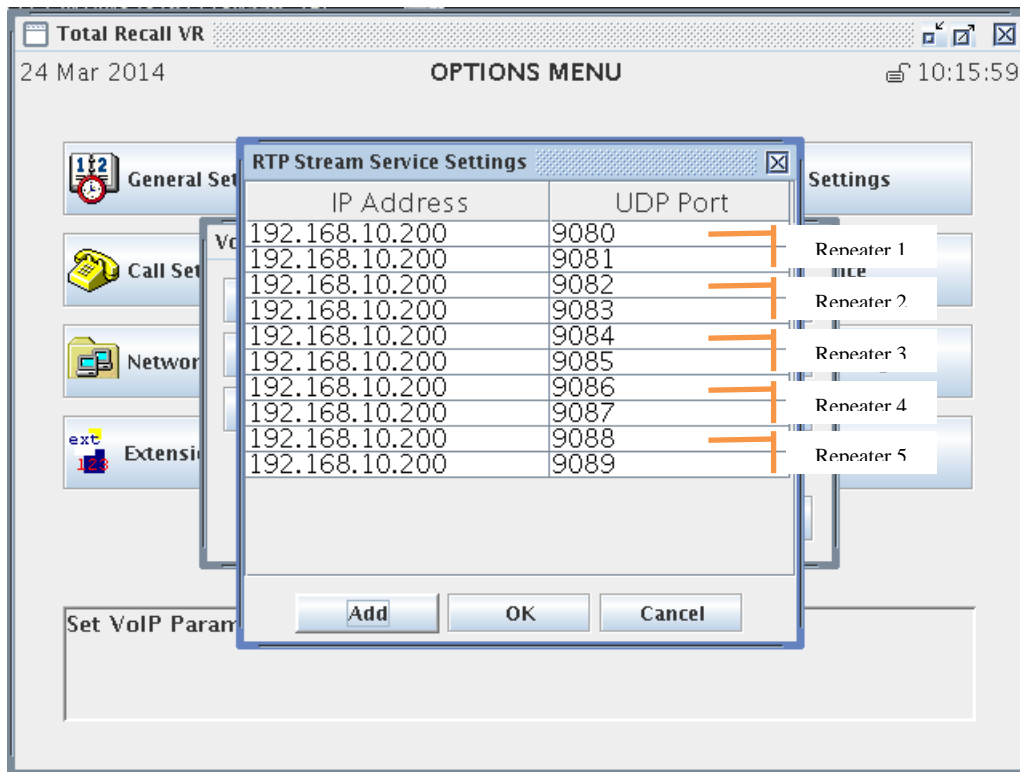

The on each repeater use the Application Programming Interface screen to configure:

- Forward to PC – tick it.
- Set Third Party Server IP to the IP address used by Total Recall VR (for example 192.168.10.200 from the previous screen capture).
- Set Radio Voice Service Slot 1 and Radio Voice Service Slot 2 to the UDP ports used by Total Recall VR (for example 9080 and 9081 from the previous screen capture).

The Application Programming Interface screen is shown on the following screen capture:

The screenshot displays the RD980 software interface, divided into a left-hand navigation tree and a right-hand configuration panel titled "Application Programming Interface".

Left Panel (Navigation Tree):

- RD980
 - Radio Information
 - Common
 - Setting
 - Feature Control
 - Microphone/VOX
 - UI Setting
 - Conventional
 - General Setting
 - Setting
 - Accessories
 - Buttons
 - Multi CTCACDC
 - Network** (highlighted with a red box)
 - Access Manager
 - CWID
 - Zone
 - [Zone]
 - Channel
 - DMR Services
 - Scan
 - Memory Watch
 - PS Developer Configuration

Right Panel (Application Programming Interface):

This panel contains various configuration settings, with a red box highlighting the "Forward to PC" section. The settings are as follows:

- Forward to PC:
- Third Party Connect Mode: Normal (dropdown)
- RTP Packet Buffer Length: 1 (spin box)
- Third Party Server IP: 0 . 0 . 0 . 0 (IP address field)
- Radio RRS Slot1 Port: 30001 (spin box)
- Radio RRS Slot2 Port: 30002 (spin box)
- Radio GPS Slot1 Port: 30003 (spin box)
- Radio GPS Slot2 Port: 30004 (spin box)
- Radio Telemetry Slot1 Port: 30005 (spin box)
- Radio Telemetry Slot2 Port: 30006 (spin box)
- Radio TMS Slot1 Port: 30007 (spin box)
- Radio TMS Slot2 Port: 30008 (spin box)
- Radio Call Control Slot1 Port: 30009 (spin box)
- Radio Call Control Slot2 Port: 30010 (spin box)
- Radio Voice Service Slot1 Port: 30012 (spin box)
- Radio Voice Service Slot2 Port: 30014 (spin box)
- Analog Call Control port: 30015 (spin box)
- Analog Voice Service port: 30016 (spin box)
- Self-Defined Message Slot1 Port: 3017 (spin box)
- Self-Defined Message Slot2 Port: 3018 (spin box)

16. Glossary

Our guides use certain terms and abbreviations.

16.1.1. Terms

Extensions

Extensions are a Total Recall VR concept that helps identify the source and the destination of recordings. Extensions can be numbers or any free format text. For example calling and called numbers can be classified as extensions if they match an entry in the Internal Dial Plan.

Extension Mapping

Extension mapping is a process used by the Total Recall VR to convert raw identifies of sources and destinations of recordings to user friendly identifiers. For example, when recording VoIP calls the 'From' and 'To' identifiers may be rather cryptic, say 'ext122@sip.myenterprise.com'. The extension mapping process can convert this identifier to '122' or 'Extension 122'.

Extension Side Recording

Extension Side Recording is used to specify that a Total Recall VR is used to record calls while connected to the office lines (extension lines) that connect desk phones to the enterprise telephone system.

Internal Dial Plan

Internal Dial Plan is Total Recall VR configuration which helps it determine which extensions are internal to the enterprise.

Recording Channel

Total Recall VR uses recording channels to capture audio on analogue, VoIP or ISDN sources. The number of recording channels can be different to the number source channels. For example, a Total Recall VR can have 20 ISDN channels while connected to an ISDN PRI link which has 30 B channels.

Remote Manager

A powerful Java™ based client application for Total Recall VR systems. It installs on Windows™ PCs and can be used to securely configure and manage multiple Total Recall VR systems over a TCP/IP network. In addition, it can be used to monitor recordings in progress in real time as well as search for and then play past recordings.

RoD Client

A small Java™ based taskbar application for Total Recall VR systems. It installs on Windows™ PCs and allows users to control in real-time which calls are recorded. In addition, enables users to add notes to recordings of calls while calls are being recorded.

Supervisor Client

A small Java™ based client application for Total Recall VR systems, It installs on Windows™ PCs and allows users to manually control (start, stop, ...) recording

on analogue channels. In addition, it can be used to monitor recordings in progress in real time as well as add notes to recordings in progress.

Total Recall VR

The system that is the subject of this manual.

Trunk Side Recording

Trunk Side Recording is used to specify that a Total Recall VR is used to record calls while connected to the trunk lines (exchange lines) that bring telephony services to the enterprise.

16.1.2. Abbreviations



Most definitions courtesy of "[Wikipedia, the free encyclopaedia](https://en.wikipedia.org/)".

CLI: Calling Line Identification

A telephony intelligent network service that transmits the caller's telephone number and in some places the caller's name to the called party's telephone equipment during the ringing signal or when the call is being set up but before the call is answered.

D/A: Digital to Analogue

A digital-to-analogue converter (DAC or D-to-A) is a device for converting a digital (usually binary) code to an analogue signal (current, voltage or electric charge).

DSP: Digital Signal Processor

A specialized microprocessor designed specifically for digital signal processing, generally in real-time computing.

DTMF: Dual-Tone Multi-Frequency

Used for telephone signalling over the line in the voice-frequency band to the call switching centre. The version of DTMF used for telephone tone dialling is known by the trademarked term Touch-Tone, and is standardised by ITU-T Recommendation Q.23. Other multi-frequency systems are used for signalling internal to the telephone network.

IP: Internet Protocol

A data-oriented protocol used for communicating data across a packet-switched internetwork.

IP is a network layer protocol in the internet protocol suite and is encapsulated in a data link layer protocol (e.g., Ethernet). As a lower layer protocol, IP provides the service of communicable unique global addressing amongst computers.

ISDN: Integrated Services Digital Network

A circuit-switched telephone network system, designed to allow digital transmission of voice and data over ordinary telephone copper wires, resulting in better quality and higher speeds than that available with the PSTN system.

LAN: Local Area Network

A computer network covering a small geographic area, like a home, office, or group of buildings.

MDF: Main Distribution Frame

A signal distribution frame for connecting equipment (inside plant) to cables and subscriber carrier equipment (outside plant).

PBX: Private Branch Exchange

Also called Private Business eXchange, or PABX (Private Automatic Branch eXchange), a PBX is a telephone exchange that serves a particular business or office, as opposed to one a common carrier or telephone company operates for many businesses or for the general public.

PSTN: Public Switched Telephone Network

The network of the world's public circuit-switched telephone networks.

RTP: Real-time Transport Protocol

The Real-time Transport Protocol (or RTP) defines a standardized packet format for delivering audio and video over the Internet.

SMDR: Station Message Detail Record

SMDR is a record containing information about recent system usage, including the identities of sources (points of origin), the identities of destinations (endpoints), and the duration of each call.

SIP: Session Initiation Protocol

An application-layer control (signaling) protocol for creating, modifying, and terminating sessions with one or more participants. These sessions include Internet telephone calls, multimedia distribution, and multimedia conferences.

TCP: Transmission Control Protocol

One of the core protocols of the Internet protocol suite, often simply referred to as TCP/IP. Using TCP, applications on networked hosts can create connections to one another, over which they can exchange streams of data using Stream Sockets.

TRVR: Total Recall VR

A professional voice logging and call recording system.

UDP: User Datagram Protocol

UDP is one of the core protocols of the Internet protocol suite. Using UDP, programs on networked computers can send short messages sometimes known as datagrams (using Datagram Sockets) to one another. UDP is sometimes called the Universal Datagram Protocol.

UPS: Uninterruptable Power Supply

A device which maintains a continuous supply of electric power to connected equipment by supplying power from a separate source when utility power is not available.

VLAN: Virtual LAN

A method of creating independent logical networks within a physical network.

VoIP: Voice over Internet Protocol

Also called IP Telephony, Internet telephony, Broadband telephony, Broadband Phone and Voice over Broadband, VoIP is the routing of voice conversations over the Internet or through any other IP-based network.

VOX: Voice Operated Switch

A switch that operates when sound over a certain threshold is detected.

[End of Document]